

BRE Good Building Guides and Good Repair Guides

A library of information for all construction professionals



To view the full range of IHS BRE Press publications visit
www.brebookshop.com

Introduction

BRE Good Building Guides and Good Repair Guides.

BRE Good Building Guides are a substantial resource of concise practical advice - helping you achieve good quality building. The complementary Good Repair Guides, published from 1996, provide practical help with defect diagnosis, assessment and repair. Drawing on BRE site experience and research, each series provides clear technical advice, practical solutions and covers a range of subjects.

An updated compilation giving a huge reference library of advice, practical guidance and expertise from BRE.

Good Building Guides give concise guidance on the principles and practicalities for achieving good quality building. They draw on BRE experience and research, and other sources, to provide clear technical advice and solutions.

Good Repair Guides are accessible guides to the defects most commonly encountered in buildings and offer sound advice on putting them right. They are highly illustrated to make the problems and solutions easy to identify and understand.

Included are pdfs of Good Building Guides, numbers 1-84 (excluding 3, 4, 5 and 25 which have been withdrawn) and Good Repair Guides, numbers 1-38.

Since the 2013 edition we have added the following new or revised publications:

[GR 38](#), [GG 73 rev](#), [GG 74 rev](#), [GG 75 rev](#), [GG 83-1](#), [GG 83-2](#), [GG83-3](#), [GG 84](#), [GG 28-1](#)

Contents

Building elements and structures

Cladding
Doors, windows and glazing
Floors, flooring and stairs
Geotechnics, soils and foundations
Masonry, walls and chimneys
Roofs and roofing
Structural design and performance

Design and management

Building design
Housing design and rehabilitation
Site organisation and management

Environment and services

Acoustics and sound insulation
Condensation and dampness
Electrical, control and IT systems
Energy and housing
Heating, insulation and air conditioning
Lighting
Radon and gas emissions
Ventilation and air quality
Water supply, drainage and sanitation
Wind, floods and climate

Fire and security

Fire safety, security and crime prevention

Materials

Composites, fibre reinforced materials and metals
Mortar, render and plaster
Paints, adhesives and sealants
Timber

Cladding

Cladding

Insulated external cladding systems

GG 31

SAMPLE

Insulated external cladding systems

GBG 31

Charles Stirling

BRE Scottish Laboratory

Government policy and rising public awareness of the advantages of reducing greenhouse gas emissions and of saving energy has led to the development of systems and materials which meet these aims.

This Good Building Guide explains how insulation can be applied to external walls and how to reduce some of the associated technical risks.

Rising awareness of the need to reduce carbon dioxide emissions and to conserve energy has led to a corresponding increase in the application of insulation systems to buildings. Many retrofitting techniques have been developed to bring existing buildings up to an acceptable standard.

With many walls, particularly solid masonry walls built before 1940 and many post-war 'non-trads', it is impossible to introduce cavity fill. In areas of high exposure, ageing joint sealant systems can't prevent moisture transferring through the external fabric to the inside. In these situations, the best solution is to apply an insulated cladding system; insulation is applied to the external surface of the existing wall and protected by a rainscreen cladding or render.



Figure 1 Rainscreen overcladding
Reproduced by kind permission of CGL, East Kilbride

Doors, windows and glazing

Doors, windows and glazing

Hot air repair of PVC-U window and door frames	GR 31
Installing domestic automatic door controls	GG 48
Installing domestic automatic window controls	GG 49
Level external thresholds: reducing moisture penetration and thermal bridging	GG 47
Repairing or replacing lintels	GG 1
Repairing timber windows Part 1: Investigating defects and dealing with water leakage	GR 10-1
Repairing timber windows Part 2: Draughty windows, condensation in sealed units, operating problems, deterioration of frames	GR 10-2

Hot air repair of PVC-U window and door frames

Good Repair Guide 31

Chris Newman

BRE Centre for Structural Engineering

The use of hot air repair on PVC-U frames is relatively new, but appears to be growing fairly rapidly. It requires a high level of training and skill to produce satisfactory

repairs. If repairs are carried out well, it seems unlikely that repair will have any long-term adverse consequences for the durability of the repaired window or door.

This Good Repair Guide describes current practice, some potential problems associated with a new technique and how repair work might develop in the future.

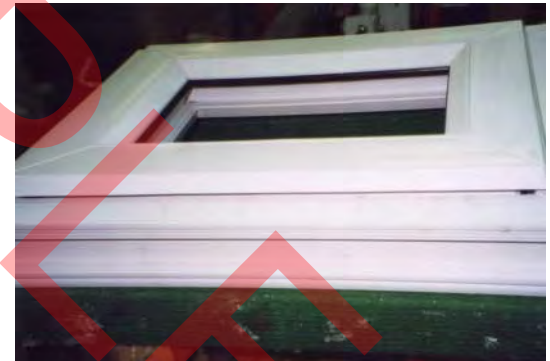

Damaged PVC-U window (left); same window following hot-air repair (right)

A substantial proportion of domestic windows in the UK is made from PVC-U (unplasticized polyvinyl chloride). PVC-U door frames and conservatories are also common, and the large market share of PVC-U in new and replacement installations means that the stock, in domestic and other applications, is growing rapidly.

To form window and other frames, PVC-U compound is extruded into long sections of 'profile'. Because PVC-U is a thermoplastic, it is possible to melt and reform the polymer, and this is used to join the profiles at the corners by

heat welding. In principle, methods involving heating and reshaping the material could be used to repair damage that might occur to windows and other PVC-U profiles.

The use of hot air repair on PVC-U frames is relatively new, but appears to be growing fairly rapidly. A high level of training and skill is needed to produce satisfactory repairs but if done well, there is no reason to believe that repair will have any long-term adverse consequences for the durability of the window or door frame concerned.

Installing domestic automatic door controls

GBG 48

S L Garvin PhD
BRE Scotland

The installation of automatic door controls can assist elderly and disabled people with access into and out of their homes. This Good Building Guide describes available

controls and how they work. It advises specifiers, manufacturers and installers on the best use of controls for disabled people and elderly users, and details technical issues concerning the installation

of the various components of the system. Involvement of the user in the specification process is essential. Questions that are commonly asked and potential problem areas are also discussed.

Further guidance

For installing domestic automatic window controls – see Good Building Guide 49

Automatic controls for doors have been used increasingly over the past 20 years to provide access to many types of building. It is now more common than not to find that automatic controls have been installed in airports, supermarkets, hotels and public buildings. The types of doors that can be fitted with automatic controls range from sliding to revolving. The increase in this type of technology has been driven at least in part by requirements for improved access to buildings for people with disabilities. The recent extension of disabled access requirements to new housing means that the use of automatic controls in these buildings will increase.

In non-domestic buildings there is often considerable freedom to design and manufacture purpose-built automatic doors. However, the domestic sector has many more restrictions that are based on the sizes of entrances to domestic buildings and the need to retain a domestic appearance.

Automatic controls are available to work for different types of doors but for domestic use the majority of controls are for hinged doors that swing into the building. For some internal uses sliding doors will be installed.



Figure 1 An internal automatic door
Courtesy of Dorma

Installing domestic automatic window controls

GBG 49

S L Garvin PhD
BRE Scotland

The installation of automatic window controls can assist elderly and disabled people to use windows where they would not be able to use manual hardware. This Good Building Guide describes available

controls and how they work. It advises specifiers, manufacturers and installers on the best use of controls for disabled people and elderly users, and details technical issues relating to the installation to different types of

frames. Involvement of the user in the specification process is essential. Questions that are commonly asked and potential problem areas are also discussed.

Further guidance

For installing domestic automatic door controls – see Good Building Guide 48

Automatic controls for windows have generally been used in order to allow natural ventilation of buildings, mostly of offices and other large buildings. However, similar types of automatic controls can be used for windows in housing. This is particularly useful where elderly and/or disabled people live independently and need assistance with opening and closing windows.

Automatic controls are available to work in different ways for different types of windows. Most are designed to be retrofitted to existing windows, and it is these types that are considered in this *Good Building Guide*. Products that have been developed to be integral with the window frame are not discussed. The automatic controls are generally designed to work with casement windows, although products exist for use with sliding and 'tilt & turn' windows.

Good installation of automatic controls is important to long-term performance. Problems introduced at installation can lead to premature failure or to a need for more maintenance than



Figure 1 Window with an automatic control installed (at a field trial in Scunthorpe)

intended. Both these factors affect the whole life costs of the controls and therefore the value of the installation to the client. This is particularly important in the housing sector where it is likely that the purchaser is an individual homeowner, local authority or registered social landlord.

Level external thresholds: reducing moisture penetration and thermal bridging

Charles Stirling

BRE Scotland

Level thresholds, where the internal and external walking surfaces are level, or almost level, are increasingly being specified to give access to the elderly and disabled. Level thresholds present a potential weakness in the

weatherproofing resistance of door openings which may let water in. Given the need for a level structural element which extends through the external wall connecting an external ramp or access way to the internal floor

there is also a risk of thermal bridging at the threshold. This Good Building Guide describes some of the technical risks associated with the design of level thresholds and some detailing solutions.

A level threshold exists where the external landing of the door threshold or sill and the internal floor finish are level within acceptable limits. The objective of such a design is to make the thresholds of dwellings more accessible to wheelchair users and people with limited mobility (see DETR's *Accessible thresholds in new housing*). However, in creating this level threshold there are risks of water entering the building and of thermal bridging. These risks must be reduced or eliminated in the design or construction of the threshold.

Although the guidance within this *Good Building Guide* is targeted at the moisture and thermal bridging risks that arise, the designer should also be aware of the additional spatial needs of disabled people or those with walking difficulties. Wheelchair users, for example, may be able to traverse individual obstacles at floor level. However, several barriers in quick succession, for example, a large step, threshold bar or a slope may provide sufficient difficulty or barrier to prevent effective entry to a building. Additionally, small steps and threshold bars may be effectively negotiated but the jarring and bumping associated with crossing these may result in pain to some wheelchair users.



Figure 1 A level threshold is where the external walking surface is level with the door threshold and the internal floor finish

This *Good Building Guide* gives advice on designing level thresholds, not only for wheelchair users but also for those with walking difficulties, who may only be able to take small, perhaps shuffling, steps and who would find even small steps and threshold bars extremely difficult. Wheelchair users and individuals with walking difficulties may also

Repairing or replacing lintels

During housing rehabilitation it is common to encounter deteriorating, inadequate or poorly installed lintels. This guide, for housing rehabilitation specialists, lists key points for assessing the structural condition of lintels in traditionally constructed walls. For the main types of lintel (timber, brick, concrete, stone and metal) it gives technical guidance on when repair is possible and when replacement is advisable. To further assist decision making, outline guidance on lintel replacement procedure is included.

More detailed guidance on assessment of loads on lintels (GBG 10) and on methods of propping during works (GBG 15) should be used in conjunction with this guide if replacement is being considered. Wider objectives laid down for a rehabilitation project, such as a need to replan interiors, may influence the choice of action.

Contents

- **Background** page 2
- **Assessment of structural condition** pages 2 and 3
- **Repair or replace?** pages 4 and 5
- **Lintel replacement guidelines** pages 6 and 7
- **Further information** page 8

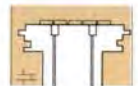

Can this lintel be repaired, or should it be replaced?

Repairing timber windows:

investigating defects and dealing with water leakage

Good Repair Guide 10

Part 1

good repair guide

Defects occur in timber windows for a number of reasons including poor design, poor installation or glazing or lack of maintenance. One of the

advantages of timber windows is that they can often be repaired without specialist skills, materials or knowledge.

Part 1 of this Guide gives advice on how to investigate the fault and what to do about water leakage.

Part 2 of this Guide

For dealing with draughty windows, condensation between the panes of sealed units, windows that are difficult to operate, deterioration of external finishes, distortion and decay of the frame, and a fuller list of publications giving further guidance – see Part 2

Many timber windows installed a hundred or more years ago are still in use today. However, many of the windows manufactured and installed between 1945 and about 1970 decayed prematurely, with poor design, manufacturing techniques and conditions in service all contributory factors. Subsequently, durability has improved significantly, particularly as a result of preservative treatments.

Vertical sliding sash windows hung on cords with balance weights were common in Victorian and Edwardian houses. These generally perform well, although in original form are less draughtproof than other types. They were designed to allow replacement of sash cords and are simple durable designs, usually made of good quality timber. They give few problems if properly maintained. It is possible to buy proprietary draughtstripping for this type of window to improve the performance, and where replacement parts are needed they can usually be made by local joinery companies. There are companies which specialise in upgrading, repairing or replacing windows in buildings of historic interest or in conservation areas. Although much of this Guide is relevant to sash windows, it deals primarily with hinged casement windows.

Windows produced by the large-scale manufacturers have generally been developed



Windows in this kind of neglected condition can be brought back to life provided no serious decay has occurred

and tested before they are manufactured for sale. Provided a window with the correct performance criteria has been selected, any problems which occur are more usually due to poor installation and/or glazing than fundamental design defects. Windows from small-scale joinery companies and purpose-built windows are less likely to have undergone a lengthy and costly 'develop and test' programme and may incorporate detail design defects causing air or water penetration.

Repairing timber windows:

dealing with draughty windows, condensation in sealed units, operating problems, and deterioration of frames

Good Repair Guide 10

Part 2

Defects occur in timber windows for a number of reasons including poor design, poor installation or glazing or lack of maintenance. One of the advantages of timber

windows is that they can often be repaired without specialist skills, materials or knowledge. Part 2 of this Guide gives advice on dealing with draughty windows,

condensation between the panes of sealed units, windows that are difficult to operate, deterioration of external finishes, and distortion and decay of the frame.

Part 1 of this Guide

For advice on how to investigate defects and what to do about water leakage – see Part 1

Some signs and symptoms of defects

- Water leakage and/or dampness at reveals
- Excessive draughts
- Condensation between the panes of sealed units
- Operating problems (stiff to open and/or difficult to close; breakage or failure of hardware)
- Early deterioration of external finishes
- Distortion and/or decay of the frame

Dealing with excessive draughts

Windows which suffer from water leakage will usually also be draughty. However draughts can occur in windows which do not leak water.

What's causing the excessive draughts?

Almost always, ineffective or absent weatherstripping

Making repairs

Existing weatherstripping can become ineffective if it's damaged or has been painted over so that it becomes hard and loses compressibility. When the casement is closed, the weatherstrip should be compressed on all four sides of the casement. If the weatherstripping fails to close the gap between the adjoining surfaces:

- the fit of the casement should be adjusted,
- a larger section weatherstrip could be fitted or weatherstrip could be fitted on both closing faces.

A wide range of weatherstripping is available for all types of window.



Early stages of decay in a softwood window

Floors, flooring and stairs

Floors, flooring and stairs

Domestic floors: Part 1. Construction, insulation and damp-proofing REVISED 2015	GG 28-1
Domestic floors: assessing them for replacement or repair: Part 2. Concrete floors, screeds and finishes	GG 28-2
Domestic floors: assessing them for replacement or repair: Part 3. Timber floors and decks	GG 28-3
Domestic floors: assessing them for replacement or repair: Part 4. Magnesite, tiles, slabs and screeds	GG 28-4
Domestic floors: assessing them for replacement or repair: Part 5. Wood blocks and suspended timber	GG 28-5
Insulating ground floors	GG 45
Repairing and replacing ground floors	GR 17

Good Building Guide

Domestic floors

Part 1: Construction, insulation and damp proofing

Rupert Pool and Chris Scivyer

This Good Building Guide (Parts 1–5) considers the construction of new and replacement domestic floors and their repair.

Part 1 describes ground floor construction in new buildings and in refurbishment work where floors are being replaced. It is concerned mainly with domestic buildings, but some recommendations apply equally to other types of building. Parts 2–5^[1, 2, 3, 4] explain how to assess different types of floor construction for replacement or repair, and how to repair them.

This guide is of interest to designers, building surveyors and builders. This update to Part 1 replaces the guidance published in 1997.

Introduction

This Good Building Guide describes the types of ground floors commonly used in domestic properties: ground-supported concrete slab floors, suspended concrete floors (including beam and block) and suspended timber floors. It provides information on how to construct each type of floor and gives advice on the positioning of damp-proof membranes (DPMs) and thermal insulation. In particular, it gives details of:

- damp proofing
- vapour-control layers
- drying times for concrete bases and screeds
- positions for thermal insulation.

This guide does not deal with:

- structural requirements
- specific values or thicknesses of thermal insulation (because they depend on individual designs)
- requirements for the exclusion of radon and methane^[5]
- heated screeds.

The reader is advised to consult a chartered surveyor, structural engineer or similarly qualified person if any of the above requirements are specified.



Figure 1: A domestic reinforced in situ concrete floor slab being poured

Ground-supported concrete slabs

Traditionally the most common type of construction for house floors in England and Wales, and still widely used on smaller projects, is a concrete slab, not less than 100 mm thick, laid directly on the ground. The concrete slab can be:

- reinforced or unreinforced
- directly finished to receive flooring
- topped with a bonded, unbonded or floating screed
- covered by wood-based sheets, such as chipboard or plywood
- covered by a flooring bedded directly to it, such as ceramic tiles.

Thermal insulation

Insulation can be incorporated within the floor. It can be glass fibre or foamed or expanded plastic sheets of appropriate compressive strength. Insulation can be positioned:

- above the structure
- below the structure
- at the edge of the structure.

Domestic floors: assessing them for replacement or repair

concrete floors, screeds and finishes

GBG 28

Part 2

This **guide** tells you how to inspect the condition of concrete floors, screeds and finishes and how to assess them for repair or replacement. It deals with the most common forms of deterioration and includes check lists to help you

inspect a floor. It is mostly about domestic floors but some recommendations apply also to other types of building.

This guide should be read in conjunction with GBG 28 Parts 4 and 5 which describe how to repair

some of the floors and floorings about which BRE receives most enquiries. It does not deal with the exclusion of radon and methane.

This guide is of interest to designers, building surveyors and builders.

Replacement and repair

If you need to replace the whole floor, refer to GBG 28 Part 1.

For guidance on repair or replacement of specific finishes, see GBG 28 Parts 4 and 5.

Survey methods

Identifying a particular kind of floor construction and flooring is not always easy. You may be able to gain access to the underside of a suspended ground floor via a trap and a crawl space, or to the underside of a suspended upper floor by removing a floor board. But with a fully enclosed floor, such as a ground supported concrete floor, some destruction may be inevitable if you don't have a drawing or specification of the original construction. If you need to find out, for example, whether there is a damp-proof membrane (dpm)

sandwiched between concrete base and screed underneath a tile flooring, you may be able to take a core through the screed (Figure 1) within a cupboard space. Then you must balance the severity of problem with the consequences of making good any damage. It is, of course, much more difficult to determine the presence of a dpm beneath the slab.

You may be able to minimise damage by using an optical probe. These can be useful but must be used with caution, since the field of view is restricted.



Figure 1 Core through cracked screed. This core was taken at the intersection of four shrinkage cracks and shows clearly that the screed has lipped and curled.

Domestic floors: assessing them for replacement or repair

timber floors and decks

GBG 28

Part 3

This guide tells you how to inspect the condition of timber floors and decks and how to assess them for repair or replacement. It deals with the most common forms of deterioration and includes check lists to help you

inspect a floor. It is mostly about domestic floors but some recommendations apply also to other types of building.

This guide should be read in conjunction with GBG 28 Parts 4 and 5 which describe how to repair

some of the floors and floorings about which BRE receives most enquiries. This guide is of interest to designers, building surveyors and builders. It does not deal with the exclusion of radon and methane.

Replacement and repair

If you need to replace the whole floor, refer to GBG 28 Part 1.

For guidance on repair or replacement of specific finishes, see GBG 28 Parts 4 and 5.

Survey methods

Identifying a particular kind of floor construction and flooring is generally easier with suspended timber floors than it is with solid concrete floors. You can probably gain access to the underside of a suspended ground floor via a trap and a crawl space, or to the underside of a suspended upper floor by removing a floor board.

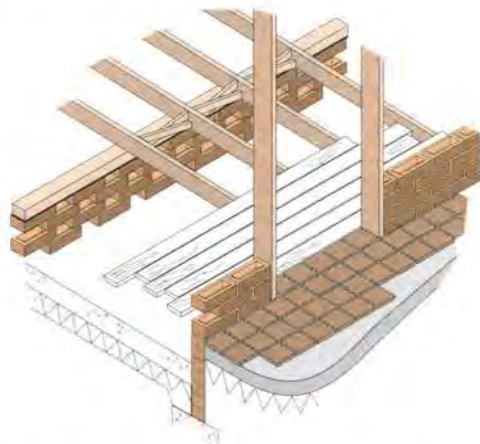

Figure 1 Suspended timber floor adjoining quarries laid on ash bed

Before 1940, ground floors in housing commonly consisted of suspended timber on sleeper walls; this floor construction remains common in Scotland. Kitchens and out-houses often had quarry tiles laid directly on the earth, on a bed of ashes or on a concrete base. Upper floors were mainly suspended timber with tongue and groove boards and ceilings were lath and plaster. Plasterboard ceilings replaced lath and plaster around the mid 1920s.

The *English House Condition Survey* indicates that one ground floor in about eight has faults and there are nearly ten times as many flooring faults as there are structural ones.

BRE surveys of faults show that:

- 40% involve cracking
- 20% involve detachment of the finish
- 15% involve entrapped water
- 25% are due to other causes.

Condensation on floors is rare: dampness in existing floors is more often caused by spillage and leaks.

Nearly all upper floors have faults, most of them minor. Faults in the decking outnumber faults in the structure by nine to one.

The chance of finding structural faults in the upper floors of houses built before 1919 is about double that in newer houses.

Domestic floors: repairing or replacing floors and flooring magnesite, tiles, slabs and screeds

GBG 28

Part 4

The Building Research Establishment receives many enquiries about repairs to floors and floorings. This guide

describes some of the common ones. It is concerned mainly with domestic buildings but some recommendations

are equally applicable to other types of building. This guide is of interest to designers, building surveyors and builders.

Other floors and flooring

GBG 28 Part 5 deals with repairs to wood blocks and suspended timber floors.

This guide tells you how to repair floorings which have been in use for a number of years. It describes their composition and how they were commonly laid; this can have a considerable effect on what replacements are possible. It deals with the following floorings:

- magnesium oxychloride (magnesite)
- thermoplastic and vinyl (asbestos) tiles
- ceramic tiles
- concrete slabs and screeds

They are among the most common ones for which BRE receives requests for advice; written information on some of them is scarce.



Figure 1 Mottled magnesite floor – see page 2

Domestic floors: repairing or replacing floors and flooring

GBG 28

Part 5

Wood blocks and suspended timber

The Building Research Establishment receives many enquiries about repairs to floors and floorings. This guide

describes some of the common ones. It is concerned mainly with domestic buildings but some recommendations

are equally applicable to other types of building. This guide is of interest to designers, building surveyors and builders.

Other floors and flooring

GBG28 Part 4 deals with repairs to magnesite, tiles, slabs and screeds.

This guide tells you how to repair floorings which have been in use for a number of years. It describes their composition and how they were commonly laid; this can have a considerable effect on what replacements are possible.

It deals with wood blocks and suspended timber floors and floorings.

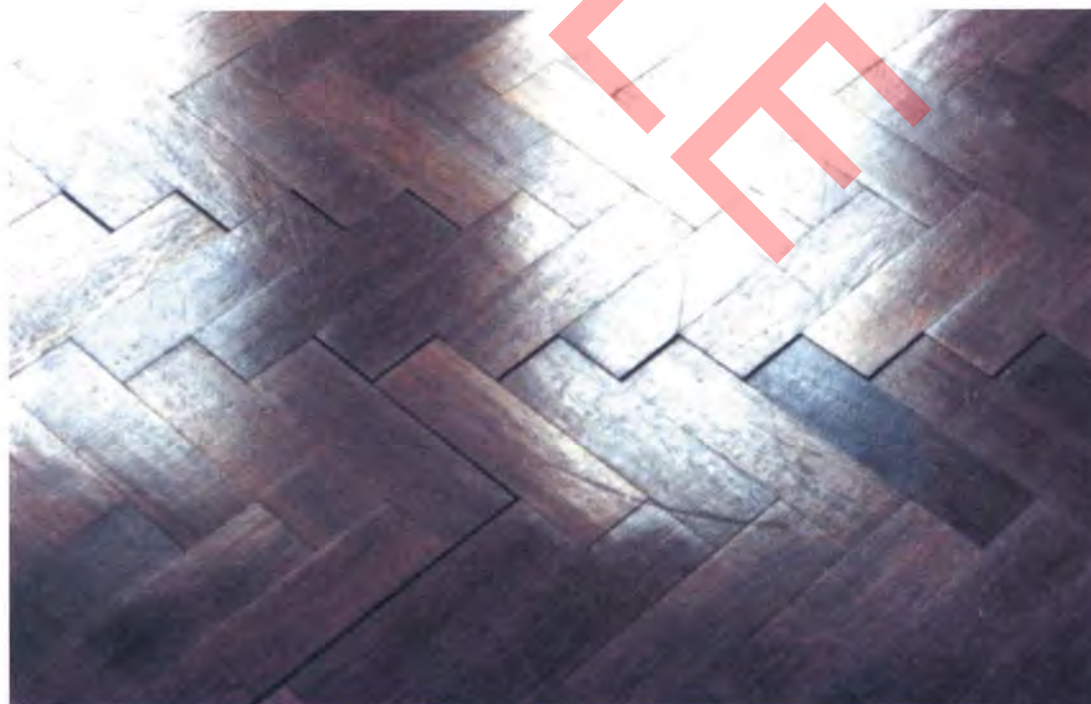

Figure 1 Rafting failure in a wood block floor – see page 2

Insulating ground floors

Charles Stirling

BRE East Kilbride

It has historically been common practice to insulate upper floors to reduce sound transmission between apartments and to reduce heat loss to external air spaces, eg above car parking and access ways. Since 1990

there has been a requirement by Building Regulations to insulate ground floors to reduce energy consumption. With ever-increasing pressure to reduce energy usage, thicker levels of insulation will be required within the

floor construction. This Good Building Guide highlights typical installation techniques, materials, insulation thicknesses and the potential technical risks in achieving improved thermal standards.

Ground floor construction

The construction of ground floors typically includes: ground supported concrete slabs, suspended concrete floors (including beam and block systems), and suspended timber floors. *Good Building Guide 28, Part 1* provides specific constructional details for these floors. A primary function of the ground floor construction is to prevent the transfer of moisture, as liquid water or water vapour, from the surrounding ground through the floor construction and into the interior of the building. Damp-proof membranes (dpms) used to prevent moisture, water vapour or ground contaminants from reaching the inside of the building should be continuous with any vertical and horizontal damp-proof courses (dpc). The alternative positioning and detailing of dpms is dealt with in *Good Building Guide 28*.

A range of thermal insulation materials is available for use in improving the thermal performance of ground floors. The choice of insulation should be appropriate to the specific application and should have the required density, or compressive strength, and water absorption characteristics appropriate for the location.

Insulation materials

A range of commercially available insulation materials can be used to insulate ground floors. The choice of individual insulation material should be based on those material properties required by the installation. The retrospective fitting of insulation in ground floors can be carried out but due to its disruptive nature is

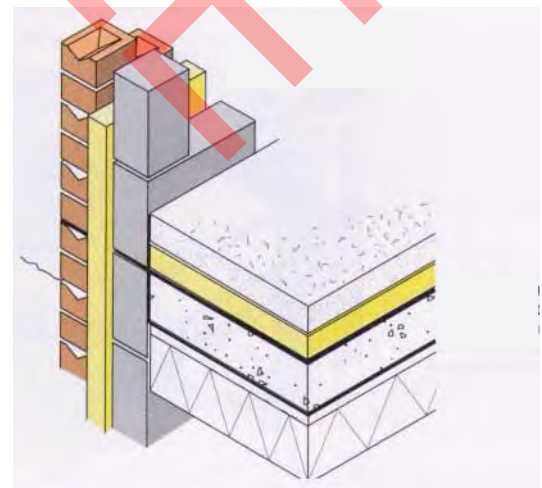

Figure 1 Wall and floor insulation should meet or overlap

Repairing and replacing ground floors

Good Repair Guide 17

good repair guide

Putting in a new ground floor or repairing a defective one is often necessary in older properties as part of a refurbishment programme. Sometimes this is

straightforward, but often there are faults that must be put right before refurbishment can start. This Good Repair Guide gives advice on how to assess the condition of two

typical domestic ground floors (solid concrete and suspended timber) before starting refurbishment, and how to repair or replace them.

It is vital that floors are carefully surveyed before any work is done on them; it is all too common for faults to remain undiscovered until work is well under way. This *Good Repair Guide* looks at two typical examples of floors needing repair:

- l a solid concrete floor with a finish of thermoplastic or vinyl (asbestos) tiles, and
- l a suspended timber ground floor.

It explains what to look for before starting work, and how to go about repairing or replacing it.

Concrete floor with thermoplastic or vinyl tiles

Many of the houses built in the 1950s and 1960s and now undergoing rehabilitation have solid concrete ground floors, finished with thermoplastic or vinyl (asbestos) tiles. Thermoplastic tiles were introduced into the UK in 1947. Vinyl (asbestos) tiles became available in about 1954, manufactured by the same process but more resistant to fat, oil and abrasion, and slightly more flexible. With a wider colour range, vinyl tiles slowly gained market share from thermoplastic tiles.

Both types were water-resistant and the bitumen adhesives used made them

moderately resistant to damp from below. So the flooring was often laid without a damp-proof membrane (dpm), and this worked well except on very wet sites. A dpm did not become a requirement until the mid-1960s; by then, polyethylene sheets of suitable size and thickness were available.

The tiles may have been laid on a screed or direct on the slab. The sub floor had to be flat because the tiles were brittle and would not support loads where they spanned high spots.

Assessing the condition

Dampness

Worn or damaged thermoplastic tiles can, of course, be replaced with any material which is impervious to moisture. But if you intend to replace them with a moisture-sensitive floor finish, such as chipboard or other wood-based materials, flexible PVC, linoleum, cork tiles or carpet, you will need to measure the moisture condition of the base.

If the base is dry, it should be possible to lay the new flooring without adding a dpm. If the base is damp, you will need to identify and rectify the source of dampness, and then lay a new dpm (see *Damp-proofing* on page 3).

Geotechnics, soils and foundations

Geotechnics, soils and foundations

Basement construction and waterproofing: Part 1: Site investigation and preparation	GG 72-1
Basement construction and waterproofing: Part 2 Construction, safety, insulation and services	GG 72-2
Building on brownfield sites: Part 1. Identifying the hazards	GG 59-1
Building on brownfield sites: Part 2. Reducing the risks	GG 59-2
Cracks caused by foundation movement	GR 1
Damage to buildings caused by trees	GR 2
Foundations for low-rise building extensions	GG 53
Simple foundations for low-rise housing: Part 1. Site investigation	GG 39-1
Simple foundations for low-rise housing: Part 2. 'Rule of thumb' design	GG 39-2
Simple foundations for low-rise housing: Part 3. Groundworks: getting it right	GG 39-3

Basement construction and waterproofing:

Site investigation and preparation

GBG 72

Part 1

Peter Trotman

The requirement for building on sloping sites or increasing the area of buildings within limited height and footprint can often be met by incorporating a basement. The basement was popular in Victorian and Georgian times, particularly in housing, and recent industry initiatives have confirmed that there are still economic benefits to be had from including a basement.

One of the main challenges to be considered when designing below-ground accommodation is preventing water or water vapour ingress. Part 1 of this Good Building Guide outlines the principles of constructing a waterproof basement and Part 2 describes the main methods of perimeter construction with advice on safety, insulation and installation of services.

Figure 1 Basement under construction on the BRE Innovation Park



Courtesy of Hanson

The economic case for incorporating a basement is obvious on city centre sites where deep basements for storage or car parking are common.

Basements were common in Georgian and Victorian times but rare in the 20th century when houses tended to be built on the ground on shallow foundations. Present day trench fill foundations are at least a metre deep and on clay or poor soils can be as much as 3.5 metres deep. In these circumstances, extending the foundations a little further and extending the excavation to create a basement becomes an economically viable proposition.

The Basement Information Centre (TBIC, previously the Basement Development Group or BDG) made cost estimates in 1991 (BDG), 1999 (BDG) and 2005 (TBIC) for various basement configurations. The 2005 cost estimate shows a typical three-bedroom detached house with a fully below-ground basement, divided into rooms and fully furnished to cost only 6.7% more than a house of similar size without a basement (11.5% in 1991 and 8.7% in 1999). A similar house with a

partial basement was shown to cost only 1.9% more in 2005. Although the construction costs for a basement house are higher than an equivalent non-basement house, there is the potential to save 21% on land costs, which will be greater than the extra cost for incorporating a basement. These figures show the increasing viability for basement houses. Energy costs should also show savings of around 10% for a detached basement house.

Basement construction is used for a room or rooms in a building entirely or partly below ground level, including sloping sites where the rear and side walls are earth retaining.

Requirements for the structure are that it should:

- resist soil loading,
- support the building above, and
- remain dry, internally.

A variety of wall and floor constructions and waterproofing systems are available to the designer.



Basement construction and waterproofing:

Construction, safety, insulation and services

GBG 72

Part 2

Peter Trotman

The requirement for building on sloping sites or increasing the area of buildings within limited height and footprint can often be met by incorporating a basement. The basement was popular in Victorian and Georgian times, particularly in housing, and recent industry initiatives have confirmed that there are still economic benefits to be had from including a basement.

One of the main challenges to be considered when designing below-ground accommodation is preventing water or water vapour ingress. Part 1 of this Good Building Guide outlines the principles of constructing a waterproof basement and Part 2 describes the main methods of perimeter construction with advice on safety, insulation and installation of services.



Figure 1 Semi-basement under construction for the BRE Integer House

The method adopted for basement construction will depend on a number of factors:

- whether it is a sloping site or a full excavation,
- the depth and extent of the basement,
- the specialism of the contractors employed to construct the basement,
- the potential level of the water table,
- the level of tanking required to prevent water ingress (see *Part 1*).

For domestic construction, a partial basement on a sloping site where only the rear wall and part of a side wall is earth retaining (Figure 1) is more likely than a full depth basement.

If effective drainage is provided to reduce the groundwater level, simple perimeter wall designs can be used (eg Type A tanked or Type C structures; see *Part 1, Figure 3*). Effective drainage can be provided using cut-off drains at ground level and perimeter drains below slab level.

Construction methods for domestic-scale basements

Blockwork walls (Figure 2)

Blockwork walls are built of two leaves of at least 100 mm thick with a grouted cavity of 100 mm width. Reinforcement which has been set in the foundation slab is taken up inside the grouted cavity. Horizontal reinforcement should be provided for the full length of the wall with adequate lapping and continuity at corners.

In-situ reinforced concrete (Figure 3)

Reinforcement for in-situ reinforced concrete walls should comply with BS 4449 and be supported to give a concrete cover of 40 mm to both the inside and outside face of the wall.

Precast insulated panels (Figure 4)

Precast insulated panels are factory-cast, storey-height reinforced and insulated concrete panels erected onto a site-poured concrete foundation slab. Units can incorporate door and window openings. In the example shown in Figure 4,





Figure 8 Services passing through the basement wall must be properly waterproofed otherwise leakage (as seen in the photo) may occur

basement structure should allow for differential movement of the pipe and the structure. An alternative method is to use a macerator and pump to discharge to a stack above the level of the basement.

Heat-producing appliances

These appliances should be installed in accordance with Approved Document J of the Building Regulations (England & Wales).

LPG storage containers should not be located in basements. If LPG installations are fitted in buildings with a basement, an LPG detector that complies with BS EN 50244 should be fitted not more than 200 mm above the floor of the basement, unless low-level direct ventilation is possible.

Air supply to appliances must be provided as required by the relevant national building regulations or the appliance should be room sealed. Refer to Approved Document J for permitted balanced flue locations.

Vehicle access

Vehicle access ramps to single-family dwellings should not be steeper than 1 in 6. For basement car parking the ramp should not exceed 1 in 10, or 1 in 7 for short lengths with a transition length at the top and bottom of the ramp. The transition points should be eased to prevent vehicles grounding. Ramps should have a textured or ribbed surface and a drainage channel to prevent rainwater entering the basement.

References and further reading

BRE

BRE. *Part L explained: the BRE guide.* BR 489. 2006

BRE. *Designing quality buildings: a BRE guide.* BR 487. 2007

Harrison H W & Trotman P M. *Foundations, basements and external works. Performance, diagnosis, maintenance, repair and the avoidance of defects.* BR 440. 2002

Trotman P, Sanders C & Harrison H.

Understanding dampness. BR 466. 2004

Good Repair Guide

23 Treating dampness in basements

Information Papers

13/94 Passive stack ventilation systems: design and installation

14/94 U-values for basements

British Standards Institution

BS 4449: 2005 Steel for the reinforcement of concrete. Weldable reinforcing steel. Bar, coil and decoiled product. Specification

BS 5588-1: 1990 Fire precautions in the design, construction and use of buildings. Code of practice for residential buildings

BS 6262-4: 2005 Glazing for buildings. Code of practice for safety related to human impact

BS 8110-1: 1997 Structural use of concrete. Code of practice for design and construction

BS EN 12600: Glass in building. Pendulum test. Impact test method and classification for flat glass (Various Parts)

BS EN 50244: 2000 Electrical apparatus for the detection of combustible gases in domestic premises. Guide on the selection, installation, use and maintenance

prEN 13564-1: 2002 Anti-flooding devices for buildings. Requirements

Johnson R A. *Water-resisting basements: a guide.*

Safeguarding new and existing basements against water and dampness. R139. London, CIRIA, 1995

Department for Communities and Local Government.

Building Regulations. 2000. Approved Documents:

B: Volume 1 Dwellings, Volume 2 Buildings other than Dwellings (2006 edition)

E: Resistance to the passage of sound (2003 edition, amended 2004)

F: Ventilation (2006 edition)

J: Combustion appliances and fuel storage systems (2002 edition)

L1A: Conservation of fuel and power (New dwellings) (2006 edition)

L2A: Conservation of fuel and power (New buildings other than dwellings) (2006 edition)

Available from www.planningportal.gov.uk

Northern Ireland Office. Building Regulations (Northern Ireland) 2000. Technical Booklets:

E: Fire safety

F: Conservation of fuel and power

G: Sound

H: Stairs, ramps, guarding and protection from impact

K: Ventilation

N: Drainage

P: Unvented hot water storage systems

Available from www.tsoshop.co.uk

Scottish Building Standards Agency (SBSA).

Technical standards for compliance with the Building (Scotland) Regulations 2004. Available from www.sbsa.gov.uk

The Basement Information Centre (TIBC).

Approved Document: Basements for dwellings. 2nd edition. 2004. www.basements.org.uk

Yandzio E & Biddle A R. *Steel intensive basements.* P275. Ascot, Steel Construction Institute, 2001

Good Building Guides give concise guidance on the principles and practicalities for achieving good quality building. They draw on BRE experience and research, and other sources, to provide clear technical advice and solutions.

Digests, Good Building Guides, Good Repair Guides and Information Papers are available on subscription through BRE Connect. Details at: www.BREconnect.com

BRE is committed to providing impartial and authoritative information on all aspects of the built environment for clients, designers, contractors, engineers, manufacturers and owners. We make every effort to ensure the accuracy and quality of information and guidance when it is published. However, we can take no responsibility for the subsequent use of this information, nor for any errors or omissions it may contain.

BRE is the UK's leading centre of expertise on the built environment, construction, energy use in buildings, fire prevention and control, and risk management. Contact BRE for information about its services, or for technical advice: BRE, Garston, Watford WD25 9XX
Tel: 01923 664000
enquiries@bre.co.uk
www.bre.co.uk

BRE publications are available from www.ihsbrepublish.com or IHS BRE Press
Willoughby Road
Bracknell RG12 8FB
Tel: 01344 328038
Fax: 01344 328005
Email: brepublish@ihs.com

Requests to copy any part of this publication should be made to the publisher:
IHS BRE Press
Garston, Watford WD25 9XX
Tel: 01923 664761
Email: brepublish@ihs.com

GG 72, Part 2

© BRE 2007
September 2007
ISBN 978-1-86081-982-7
(Part 2)
ISBN 978-1-86081-983-4
(2-Part set)

bre

Building on brownfield sites: identifying the hazards

GBG 59 Part 1

J A Charles

A national target has been set to build 60% of new housing on brownfield sites. These sites can contain a variety of hazards that can pose significant risks for developers, designers, house builders, insurers and house owners. Part 1 of this Good Building Guide describes the hazards commonly encountered on brownfield land. The significance of these hazards for housing developments and the ways in which they can be identified are explained. Part 2 of the guide describes how the risks can be managed and, where necessary, reduced. It also indicates the different regulations that can impact on the development of brownfield sites.



Figure 1 Underground obstructions and buried foundations

Industrial and mining activities can cause physical, chemical and biological damage to the land. For many years there has been concern over the dereliction and contamination that have been left by these activities, and the reclamation and re-use of such sites has been an important aspect of government policy. Recently, the term brownfield has been widely used to describe previously developed land; it represents a broader concept than either derelict land or contaminated land since a brownfield site is not necessarily either derelict or contaminated (see Box 1).

Maximising the re-use of previously developed land has many benefits, including:

- minimising the amount of greenfield land being taken for development, and
- regenerating parts of the UK where declining industries have left large areas of dereliction.

This *Good Building Guide* presents an overview of the subject of building on brownfield sites and gives guidance of a general nature. Professionals working

Box 1 Definition of brownfield land

Although the term brownfield is widely used, it has no universally recognised definition. It has sometimes been regarded as being synonymous with contaminated land, but more commonly it has been understood to be the opposite of greenfield in planning terms.

Greenfield is taken to mean land that has not been previously developed, whereas brownfield is regarded as any land that has been previously developed, particularly where it has been occupied by buildings or other types of permanent structure and the associated infrastructure.

It is in this sense that the term brownfield is used in this *Good Building Guide*: brownfield land may contain contamination, but it represents a much broader concept than contaminated land.

While this Guide is concerned with the particular hazards commonly encountered on brownfield sites, it does not imply that greenfield sites are without hazards.

in this area should remember that on most brownfield sites the services of specialists with expertise in appropriate disciplines will be needed.

Building on brownfield sites: reducing the risks

GBG 59 Part 2

J A Charles

A national target has been set to build 60% of new housing on brownfield sites. These sites can contain a variety of hazards that can pose significant risks for developers, designers, house builders, insurers and house owners. Part 1 of this Good Building Guide described the significance of these hazards for housing developments. In Part 2, the ways in which the risks can be managed and, where necessary, reduced, are outlined. Risk mitigation can include ground remediation techniques which are implemented before building and defensive measures which are adopted in the design of foundations, substructure and services. Regulations which can impact on the development of brownfield sites are listed in an Appendix (page 8).



Figure 1 Installing vibrated stone columns

Urban regeneration necessitates the redevelopment of old industrial sites and many other types of brownfield land. Such sites present considerable opportunities for building developments, but they can also present a variety of hazards not present on greenfield sites. While the risks for building developments on brownfield sites should not be ignored, the development of greenfield sites may not necessarily be problem-free and the redevelopment of brownfield sites can have significant benefits.

Once the principal hazards at a brownfield site have been identified (see *Part 1* of this *Guide*) the risks that they pose for the proposed building development should be assessed. Appropriate action can then be determined and a technically adequate site-specific solution can be selected and implemented. Some form of remediation may be necessary not only to make the ground suitable for

the proposed use but also to prevent or minimise the risk of harm to people, groundwater and other aspects of the natural environment. However, the remedy for one hazard can create a problem in another area and it is necessary to have a fully integrated approach to the various problems encountered at the site.

Risk management

Ground-related hazards for the built environment are sometimes substantial and not all risk associated with subsurface conditions can be avoided or eliminated. Given that ground conditions may be poor at brownfield sites, an adequate understanding of the hazards is essential. The risks should be manageable and controllable provided that they are identified in time. In many cases, risks can be reduced without major expense.

This *Good Building Guide* presents an overview of the subject of building on brownfield sites and gives guidance of a general nature. Professionals working

in this area should remember that on most brownfield sites the services of specialists with expertise in appropriate disciplines will be needed.

Cracks caused by foundation movement

Good Repair Guide 1

good repair guide

Nearly all buildings have cracks in them. There are many different causes of cracking, but most of them are not associated with foundation movement — cracks are much more likely to be the result of

changes induced by moisture or temperature. The possibility that cracking may indicate progressive foundation movement, sometimes results in expensive, and unnecessary, remedial

work. There has been a dramatic increase in demand for remedial underpinning since the early 1970s, but this is largely attributable to factors not directly related to construction.

What can you see?



- | Cracks in the outside wall which also show on the inside wall (as in the building shown here)
- | Cracks extending through the dpc into the foundation
- | Cracks are wide close to the foundations, and get narrower as they move up the building OR
- | Cracks are wide at the top of the building, and get narrower as they move towards the foundations
- | Window and door openings distorted, causing windows and doors to jam
- | Floors slope and walls tilt



In top pictures, plaster removed to show cracking

Damage to buildings caused by trees

Good Repair Guide 2

good repair guide

In hot summers, particularly following dry winters, buildings often suffer cracking. If there is a tree nearby, it is tempting to assume the tree is responsible — and then start to think about pruning it or cutting it down. In fact,

trees are only one cause of this kind of damage so, before taking any action, it is essential to identify why the cracking has occurred. Even if it turns out that a tree is contributing to the damage, it doesn't follow that removing the tree or

cutting it back will solve the problem: it might even make it worse. Various factors — including the relative ages of the tree and the building — determine the right way to prevent further damage.

Trees cause damage directly...

The tree's woody roots grow and penetrate under the foundations and may displace them. Light structures with shallow foundations are most likely to suffer, eg garages, porches and freestanding boundary walls. It is rare for buildings to be directly damaged by trees because, for this to happen, the trees have to be very close to the structure.



...and indirectly

Trees (and other vegetation) take moisture out of shrinkable clay soils and this causes the soil to shrink. On the other hand, if trees have been removed from near the house, clay soils will take up moisture and will swell; this swelling may take place over several years. Both of these effects can result in damage to the foundations and the superstructure of the building. This guide is concerned only with indirect damage.



How to prove that trees are the cause

- | Even if there are strong pointers towards trees being the cause, eliminate the possible alternative causes of damage (see GRG 1).
- | Get a chartered engineer or suitably qualified person to investigate the site.

This property suffered subsidence and extensive cracking damage when tree roots penetrated the drains, causing them to leak into the foundations



Foundations for low-rise building extensions

There is a lack of guidance dealing specifically with foundations for low-rise buildings extensions, particularly for housing. Local practice, often established through rule-of-thumb, can vary, while

more formal procedures usually follow guidance for entire, new buildings. Owners and their builders may be required to adopt extension foundation depths that differ markedly from those of the existing

building, which can lead to confusion, dispute and even damage at the junction between old and new structures. This Good Building Guide suggests procedures to avoid these difficulties.

Low-rise building extensions can vary considerably in size and complexity, ranging from small out-houses to extensive two and three storey structures. The extent and sophistication of the ground investigation and foundation design should be tailored to the type and size of the extension, the ground conditions and the nature of the existing structure and its foundations. A simple extension, for example for a utility room, may only require a visual inspection of the ground before a simple strip foundation is concreted. A two or three storey, habitable extension, on the other hand, should require more detailed investigation of the conditions of the ground



Figure 1 A typical house extension

House extensions on the increase *Concerns remain about procurement and performance*

As the cost of moving house rises, owners are opting to extend their existing accommodation. These works are usually minor in scale and are frequently performed by small local building firms. Often there is very little

professional input into the investigation for and design of foundations for extensions. Indeed it is common for the design work to be done by the owner or a builder. Often, an architect or structural engineer is the only professional involved. In many cases this approach is adequate but there are occasions when obtaining specific foundation advice is strongly recommended.

Simple foundations for low-rise housing

GBG 39

Part 1

Site investigation

This Good Building Guide brings together essential information on the selection of foundations for low-rise housing in the UK. It deals with the key

features of a site investigation, the information needed to decide whether an engineered design is called for or whether a 'rule of

thumb' design is appropriate, the application of the rule of thumb approach, and the key features of good site work for foundations.

Other parts to this Guide

For strip footings and trench fill foundations – see Part 2

No building of any significance should be constructed without first collecting sufficient information about the site to be aware of any features that might affect the support given to the building by the ground on which it will stand. For low-rise housing it will also be essential to consider carefully whether a 'standard' solution can be safely adopted or whether what is learned from the site investigation points to the need to consult someone qualified to design 'special' foundations.

There are three main routes to the information needed:

- | the desk study,
- | the walk-over survey,
- | the direct investigation.

They normally need to be taken in that order, and together they constitute the 'site investigation'.

The main objectives of the site investigation are given in the box, page 2.

The extent of the site investigation will depend on the size of the project and on the extent to which initial examination reveals unusual conditions that need more detailed investigation.



Ground support can change unexpectedly

Photograph courtesy of Eastern Counties Newspapers Ltd

Simple foundations for low-rise housing

GBG 39

Part 2

'Rule of thumb' design

Part 2 of this Good Building Guide gives 'rule of thumb' solutions to foundation design for low-rise housing. It deals exclusively with the commonest forms of housing: one- or two-storey construction for houses and flats to which Approved

Document A, Sections 1 and 2 (of the Building Regulations, England & Wales) would apply. It is also intended exclusively for housing in which the ground floor is suspended and of pre-cast concrete beam and block

construction or in which the ground floor is a ground-supported slab. For other constructions consult BS 8103.

Other parts to this Guide

For site investigation – see Part 1

For advice on good site practice – see Part 3

For the purposes of this Guide 'low-rise housing' is defined as 'detached, semi-detached and terraced houses and flats (with not more than four self-contained dwelling units per floor accessible from one staircase), of *not more than two storeys above ground*, intended for domestic occupation and of *masonry construction* with timber roofs and with an upper floor of timber or concrete'. Habitable accommodation in the roof space constitutes a storey.

The guidance enables the reader to:

- | determine a wall load category for external and for separating walls, depending on which walls support the intermediate floor and the roof,
- | determine a wall load category for any load-bearing internal partition walls,
- | classify broadly the soil type encountered at foundation level,
- | determine, in the light of the above, the minimum required foundation width for each wall load category and for the soil type identified.



A good firm-sided foundation trench being filled with concrete

Simple foundations for low-rise housing

GBG 39

Part 3

Groundworks: getting it right

Part 3 of this Good Building Guide gives advice on many matters of detail that site supervisors and groundworkers should follow wherever possible. It sets out guidance so that

commonly arising faults can be recognised and avoided, and the quality of site work controlled to a good standard. The focus is on strip footings and trench-fill foundations but

the guidance given is applicable to the vast majority of foundations for low-rise housing described in Part 2.

Other parts to this Guide

For site investigation – see Part 1

For 'rule of thumb' design – see Part 2

Foundations are crucial to the continuing satisfactory state of the building they support. The careful consideration given to the initial site surveys and to the design of the foundations (see *Parts 1 and 2*) deserves to be matched by equally careful site work. *Part 3* sets out guidance to groundworkers and supervisors so that commonly arising faults can be recognised and avoided and the quality of site work controlled to a good standard.

Part 3 deals with work on strip footings and trench-fill foundations. It does not deal with

foundation work for ground-supported slabs or for rafts, nor does it deal with groundwork associated with specialist foundations such as those involving piling or ground-improvement techniques. Its content is none the less applicable to the vast majority of foundations for low-rise housing as described in *Part 2*.

This Guide offers specific advice, on many matters of detail, that groundworkers should follow wherever possible, but two issues of over-riding importance that should be kept firmly in mind follow on page 2.

Concrete footings



Masonry, walls and chimneys

Masonry, walls and chimneys

Building brickwork or blockwork retaining walls	GG 27
Building damp-free cavity walls NEW REVISED 2015	GG 33
Building reinforced, diaphragm and wide plan freestanding walls	GG 19
Building simple plan brick or blockwork freestanding walls	GG 14
Cleaning external walls of buildings Part 1: Cleaning methods	GR 27-1
Cleaning external walls of buildings Part 2: Removing dirt and stains	GR 27-2
Domestic chimneys for solid fuel - flue design and installation	GG 46
Earth, clay and chalk walls: Inspection and repair methods	GR 35
Freestanding brick walls - repairs to copings and cappings	GG 17
Installing wall ties	GG 41
Insulating masonry cavity walls: Part 1. Techniques and materials	GG 44-1
Insulating masonry cavity walls: Part 2. Principal risks and guidance	GG 44-2
Insulating solid masonry walls	GG 50
Providing temporary support during work on openings in external walls	GG 15
Removing internal loadbearing walls in older dwellings	GG 20
Repairing brick and block freestanding walls	GR 28
Repairing chimneys and parapets	GR 15
Repairing damage to brick and block walls	GR 3
Replacing masonry wall ties	GR 4
Repointing external brickwork walls	GR 24
Retro-installation of bed joint reinforcement in masonry	GG 62
Supporting temporary openings	GR 25
Surveying brick or blockwork freestanding walls	GG 13
Surveying masonry chimneys for repair or rebuilding	GG 2
Temporary support for opening in external walls: assessing load	GG 10
Thin layer mortar masonry	GG 58

Building brickwork or blockwork retaining walls

GBG 27

This guide is for builders, designers and planners. It provides rule of thumb guidance for the stable construction of a range of common types of bonded brickwork and blockwork

earth retaining walls to a maximum retained height of 1.725 m. Walls of greater height should be designed by an appropriately qualified person.

For practical purposes, this guide provides a simplified classification of soils which are suitable to found on, and gives foundation and wall dimensions for several wall heights.

Contents

	Page
● Scope of this guide	1
● Types of retaining wall	2
● Simplified classification of soils	2
● Building walls in sloping ground	3
● Choosing materials	3 - 5
● Wall and foundation dimensions	6 - 7
● Construction guidelines	8 - 10
● Safety	11
● Further information	12

This guide gives advice on building small retaining walls. It complements the guidance given in *Good Building Guides 14* and *19* for building freestanding walls.

It stresses the need for good supervision in construction, not only to prevent premature deterioration but also to ensure the careful co-ordination and execution required for some forms of construction. Building reinforced walls, in particular, requires a number of complex operations to be carried out in sequence.

Warning !

If any of the exclusions in the next column apply, you should seek the advice of a chartered civil or structural engineer, or similarly qualified person.

Retaining walls specifically excluded from this guide are:

- walls higher than 1.725 m above the top of the foundation
- walls higher than 0.25 m above the retained ground
- walls for supporting banked-up soil, stored materials or buildings on the backfill close to the wall
- walls for supporting vehicles or traffic on the backfill close to the wall
- walls for supporting retained soil with a slope steeper than 1:10 immediately behind the wall (*see page 3 for minimum distance*)
- walls supporting a fence of any type other than a simple guard-rail (*see page 11*)
- walls for retaining very wet earth, peat or retained water, for example a garden pond
- walls forming part of, or adjoining, a building
- walls not constructed of bricks or blocks
- walls of dry masonry construction
- walls in areas of mining subsidence or other unstable ground
- walls where the water table lies within 0.5 m of the underside of the foundation.

Good Building Guide

Building damp-free cavity walls

Barry Reeves and Chris Scivyer

Cavity walls should be built so that the inner leaf stays dry. Many building details are designed with this express purpose and are long-established. However, dampness is still a common problem in modern buildings, due to the faulty design or construction of damp-proofing measures or the wrong choice of material. This Good Building Guide gives guidance on how to ensure that new cavity walls do not suffer from dampness problems. It is aimed at architects and designers, engineers, site managers, house builders and masonry contractors, and replaces the guidance published in 1999.

Introduction

Several Good Repair Guides deal with rain penetration and rising damp in existing buildings. This Good Building Guide looks at ways of preventing the problems occurring in new cavity wall construction. In driving rain, water leaks through the outer leaf of most cavity walls, often in quite large quantities. Provided the damp-proofing measures are correctly designed and installed and the wall itself is reasonably free from defects, the water does not reach the inner leaf, but flows harmlessly down the cavity face of the outer leaf until it reaches the footings or is directed out of the cavity via cavity trays or window/door lintels.

Defects in the outer leaf

Most of the leakage through the outer leaf is at fully or partly filled joints between the bricks and the mortar. Good workmanship can help to prevent this; it is especially important to fill the perpends properly, although this is frequently not achieved in practice. This is particularly pertinent in areas of high exposure, where driving rain can be blown through wide joints and across the cavity via bridging features such as wall ties, mortar, displaced insulation batts or brick fragments to wet the inner leaf. The type of pointing also has an effect: 'bucket handle', weathered or struck pointing have the best resistance to driving rain (Figure 2). Recessed pointing, which allows water to



Figure 1: Damage to a ground-floor flat caused by rain penetrating the inner leaf of a cavity wall via a torn and debris-filled cavity tray to a cavity wall of a flat upstairs

Building reinforced, diaphragm and wide plan freestanding walls

This Guide, for builders, designers and planners, presents rule of thumb guidance for stable construction of a range of common brick or blockwork wall types. Separate values for wall height and foundation width are given for increasing levels of exposure across the UK and solutions can be compared with complementary advice published for simple plan unreinforced walls (Good Building Guide 14).

The Guide includes notes on materials selection and good construction practice. The need for good supervision is stressed, particularly with reinforced walls, where a number of quite different building operations are involved which require careful coordination and execution.

The advice in this guide allows walls to be built up to a height of 2.5 m. Before starting you should check local planning restrictions, which may limit walls to a maximum height of 2 m or less.

Contents

- Types of wall included
page 1
- Choice of materials
page 2
- Building for stability
pages 3 to 7
- Construction guidelines
pages 8 to 9
- Safety
page 10
- Further information
page 10

Types of wall included

Advice is included on selected brick and blockwork variants of the wall types illustrated below.

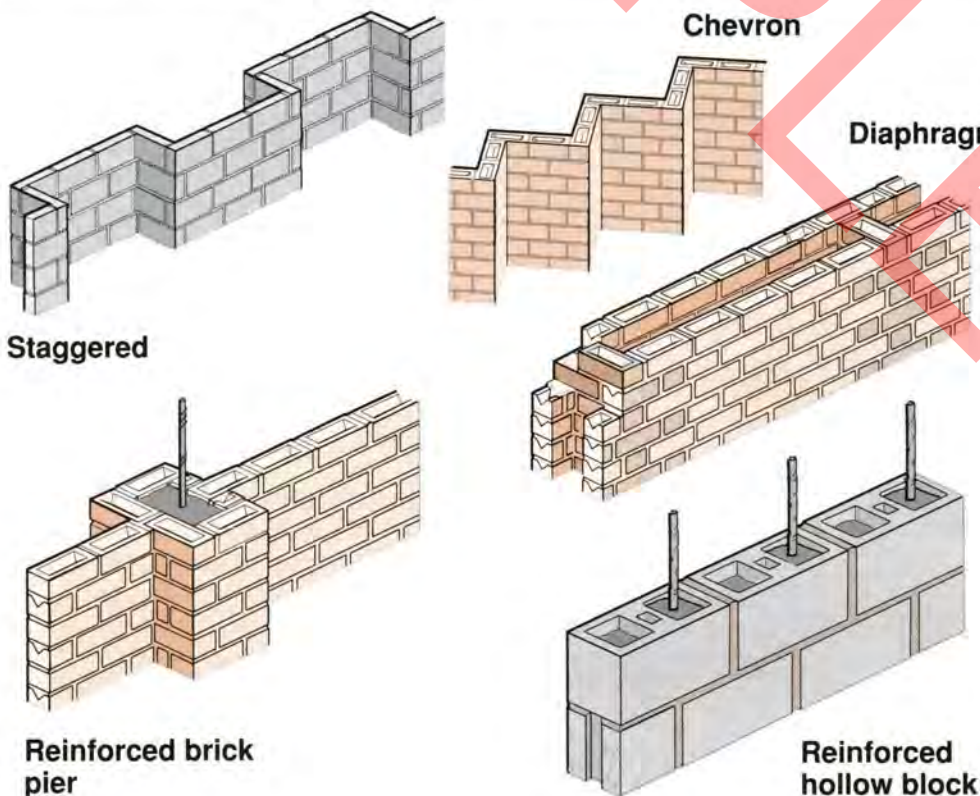

Building simple plan brick or blockwork freestanding walls

May 1994

CI/SfB (90.3) F (D6)

CAWS F10

First revision

All freestanding walls must be stable under wind load and durable under service conditions. For simple plan brick and blockwork walls this guide gives rule of thumb guidance for stable construction. It identifies the rarer situations where local conditions may require that the wall design is checked or prepared by a structural engineer. Guidance is offered on the choice of materials and on the practical details of construction which together contribute to preventing premature wall deterioration.

This guide does not cover stone walls, retaining walls or the construction of freestanding parapet walls on buildings. Good Building Guide 19 gives advice on construction options for taller walls and walls with more complex plan shapes.

Contents

- **Building for stability** pages 2 and 3

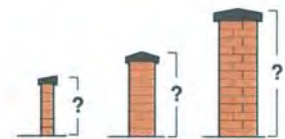

- **Choice of materials** pages 4 and 5

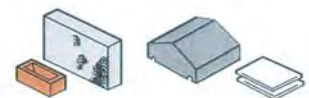

- **Construction guidelines** pages 6 and 7



- **Further information** page 8



A well constructed wall. The height to thickness ratio makes it safe. Good detailing around the capping and a low level dpc will ensure that it is durable.

Cleaning external walls of buildings: cleaning methods

Good Repair Guide 27 Part 1

Cleaning the facade of a building can enhance its appearance. It can also make the building more unsightly and damage the walling materials. Trials can help to determine

appropriate methods, risks involved and if cleaning is warranted. This guide outlines actions to take before cleaning and describes the cleaning methods available to help

surveyors, contractors and building owners decide the methods to be used and precautions needed for cleaning the walls.

Other parts to this Guide

For advice on cleaning specific soiling and stains from different wall materials – see Part 2

Should the building be cleaned?

Advantages

Cleaning can:

- | significantly improve appearance,
- | remove organic growths that hold water or produce acids,
- | remove chemical contaminants,
- | even out patchy appearance caused by repair or maintenance work,
- | reveal hidden faults.

Disadvantages

Cleaning can:

- | make the appearance patchy or uneven,
- | remove protective patination,
- | alter the colour of materials that contain pigments,
- | leave chemical contaminants,
- | increase the risk of rain penetration, frost damage and iron staining,
- | dissolve or abrade away the wall surface texture and ornamentation,
- | damage materials below, adjacent to or embedded in the area being cleaned,
- | pose risks to operatives and the public.

Before cleaning

- | First, establish the type and properties of the materials to be cleaned (expert identification may be needed) and the types of soiling.
- | Make a risk assessment of the health and safety issues involved in the cleaning of the soiled building materials.
- | Draw up a method statement for each cleaning method to be trialled, taking account of all the health and safety issues.
- | Using the method statement, arrange trials of different cleaning methods in discrete areas representing typical different soiling types and wall materials.
- | Ensure that the contractors and operatives are experienced in the particular types of cleaning work to be trialled.
- | Provide protection for adjacent materials, windows and surrounding ground.
- | Invite clients, owners and their representatives to the trials.
- | Decide on the access and safety protection requirements for operatives and the public.

Note: Information such as identification of construction materials and contractor competence can be confirmed before or after the trials.

Cleaning external walls of buildings: removing dirt and stains

Good Repair Guide 27

Part 2

Cleaning the facade of a building can enhance its appearance. However, it can also make the building more unsightly and damage the walling materials. Cleaning is best

considered when other maintenance or repair work is needed. Changes in the appearance of a building brought about by these activities can often be evened out by a

cleaning operation. This Good Repair Guide gives advice on the methods and precautions for different types of soiling on different wall surfaces to help surveyors and contractors.

Other parts to this Guide

For advice on cleaning trials and cleaning methods – see Part 1



© Crown copyright



© Crown copyright

When to clean

Before maintenance such as:

- | repainting walls,
- | repainting windows and doors,
- | repointing masonry walls.

After repair and alteration work to even out differences caused by:

- | repairing or removing sections of wall,
- | alterations to door or window sizes,
- | adding extensions,
- | drilling holes for cavity fill injection,
- | stains or organic growths from water overflow or run off from faulty plumbing.

Fletland Mill, Leeds, was converted to an hotel in 1991. Renovation work provided an opportunity to clean soiling from the brickwork

Warning!

Cleaning methods are usually destructive and can cause irreversible damage. Only go ahead if there are strong reasons for cleaning and confidence that the chosen methods and contractors will produce acceptable results.

Domestic chimneys for solid fuel: flue design and installation

GBG 46

Problems occur with chimney flues because of construction faults, and the relationship of flues to the different appliances connected to them. If the air flow through an appliance is restricted, combustion will be incomplete and gases may

vent back into the dwelling. If flue bends are not properly jointed, liners placed spigot uppermost, liners not packed out with the specified mortar, flue condensate may leak into the brickwork and gases may vent back into the dwelling.

This Good Building Guide gives advice on design and construction of chimney and flue to vent the combustion gases safely to the outside air and induce a good air flow to suit the appliance and its heat output.

The functions of a domestic chimney are:

- | to vent the products of combustion safely to the outside air and
- | to induce sufficient air flow through the flue to suit the appliance and its heat output. A chimney will fail to work correctly if the outside air temperature is only marginally different from that inside the flue, especially on start-up.

Many problems causing poor chimney performance are due to the design and construction of the flue as well as to the relation of the flue to the many different appliances which may be connected to it.

The chimney flue needs to have minimum heat loss. In principle, a chimney built within a dwelling rather than on an outside wall has the advantage of creating both a warmer house and a warm flue, although this is less important with a well-insulated chimney.

If the air flow (induced by the action of the flue) through an appliance is insufficient, combustion will be incomplete. If in addition a flue is badly constructed fumes may discharge back into the dwelling (Figure 1).



Figure 1 Smoke blow-back is a problem which has plagued householders through the ages. If the design of the fireplace and flue is flawed, downdraught can cause reversal of the smoke flow

Earth, clay and chalk walls: inspection and repair methods

GRG 35

Peter Trotman

BRE Centre for Construction Consultancy

Around the UK, a variety of earth-walling construction methods and practices have been developed over many centuries depending on the characteristics of the subsoils and on local traditions. Since the 1980s there has been a resurgence of interest in the techniques used mainly to ensure appropriate repairs for maintenance and extension of existing buildings. However, there is also a growing interest in earth-walling construction methods and practices for new build as a means of reducing the environmental impact of building and of employing more sustainable and natural building methods. This Good Repair Guide focuses on inspection of existing earth, clay and chalk walls and the use of traditional repair methods to rectify defects.



Figure 1 Rebuilt and extended cob barn in Devon
(Courtesy of Kevin McCabe)

Earth or chalk was widely used for construction of dwellings and farm buildings in many areas of the British Isles, both in loadbearing form as mass walls and as infill for timber-frame walls (Figure 2). There are distinctive techniques for construction dependent both on the characteristics of the locally available subsoils and on local traditions.

The techniques of earth walling have been revived in the 1980s and 1990s, mainly to ensure authentic repairs and maintenance of existing buildings. A few extensions and small buildings have been erected and there is much interest in the wider use of the methods for new build. As environmentally friendly systems they have great advantages:

- the materials are cheap and easily acquired:
 - the existence of many farm ponds show the sites of material extraction,
 - straw or other vegetable fibre is freely available,
- embodied energy requirements are low if mainly animal and manpower are used.

Earth-walling techniques

A variety of construction methods and practices are found throughout the UK. Materials used are subsoil, usually with a proportion of clay, and chalk. For a regional account of local traditions see Hurd & Gourley (2000).

Cob, cleam, clob or clom, whitchert, clay dabbins and mud wall

These walls are built of subsoil with a high clay content, mixed with straw and water (Figure 3), placed in situ on a stone plinth about 600 mm wide, heavily trodden down, and then pared back to an even line. Large numbers were built in the West Country up to about the end of the 19th century (in excess of 50 000 in Devon alone; Figures 1 and 4); some survive from the 1400s.

Particularly good subsoil is found between Oxford and Aylesbury and is known locally as 'whitchert', meaning 'white earth'. Chalk cob is common in Hampshire, as far north as Andover, and Dorset. Where chalk is the main constituent,

Freestanding brick walls – repairs to copings and cappings

This Guide gives recommendations for repair of deteriorated copings or cappings on existing walls. The recommendations are equally suitable for use on walls where copings or cappings are being reinstated on a wall which is being lowered in height to reduce risk of collapse.

Choices of materials and detailing, including traditional options, are given for locations with low or high risk of frost damage. Additional guidance is given for situations where more secure copings or cappings are needed.

BRE Good Building Guide 13 (1) gives guidance on assessment of existing walls and should be consulted before work starts, particularly if there is any concern over the stability or durability of the wall under consideration.



Repair must correct the absence of an upper dpc and the lack of a drip on the coping



A failed capping. Which materials and details will provide a durable repair?

Installing wall ties

GBG 41

Ties are essential in cavity walls to ensure that the wall is structurally sound and stable. A cavity wall is as strong as a solid wall only if the two slender leaves are securely tied together. Lack of skill or care in

installing ties can lead to distortion, cracking, or — in extreme cases — collapse of the outer leaf. The outside leaf is also the vital rain shield for the building. If ties are badly installed, this can lead to

rain penetration and dampness in the inner leaf. This Good Building Guide gives good practice advice on installing wall ties in new building.



Poorly installed, missing or failed wall ties can result in collapse of the outer leaf in high winds...
...or rain penetration and damp patches inside

Ties which are too widely spaced, especially at openings, ties which are not long enough to bed into both leaves by at least 50 mm, or ties which are not correctly bedded can result in collapse of a cavity wall. If ties slope the wrong

way, if the drips are off-centre or inverted, or if ties are fouled by mortar, rain can cross the cavity. This *Good Building Guide* summarises good practice for installing wall ties in new construction.

Insulating masonry cavity walls: techniques and materials

GBG 44

Part 1

Charles Stirling
BRE East Kilbride

With increasing pressure to provide ever thicker levels of insulation there is concern that thermally upgrading conventional cavity walls, consisting of two leaves of masonry,

may prove impracticable. Part 1 of this Good Building Guide highlights techniques and materials for insulating cavity walls. Part 2 provides guidance on how to reduce the

associated technical risks. The guidance is for cavity walls having two masonry leaves; it is not suitable for timber-framed construction.

Cavity wall construction

Cavity wall construction initially became widely built during the 1920s when it was used, principally, to reduce the risk of rain penetration. Its use has subsequently increased and since 1945 the majority of houses built in the UK have been of cavity construction. Early cavity walls consisted of two leaves of brickwork tied together with metal ties to form a cavity, nominally 50 mm wide. As thermal regulations improved, lightweight masonry was introduced into the inner leaf and insulation was subsequently introduced into the cavity. However, with pressure to improve thermal performance further there is a need to increase the level of insulation beyond the conventional 50 mm cavity width thereby increasing the wall thickness. The wall thickness may need to be further increased where a clear cavity is also required behind the outer leaf for drainage purposes in areas of high exposure. This has led to concerns that the use of twin-leaf masonry construction may become impracticable and uneconomic to build.

In order to provide some indication of the possible effect of developments in thermal standards an example is given below. A typical

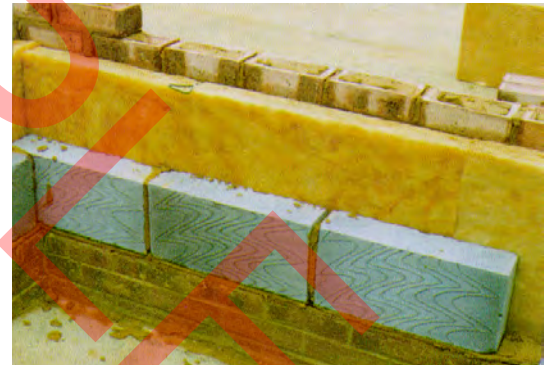

Mineral wool insulation batts used as full fill insulation



Plastics insulation used as partial cavity insulation

Insulating masonry cavity walls: principal risks and guidance

GBG 44

Part 2

Charles Stirling
BRE East Kilbride

With increasing pressure to provide ever thicker levels of insulation there is concern that thermally upgrading conventional cavity walls, consisting of two leaves of masonry,

may prove impracticable. Part 1 of this Good Building Guide highlights techniques and materials for insulating cavity walls. Part 2 provides guidance on how to reduce the

associated technical risks. The guidance is for cavity walls having two masonry leaves; it is not suitable for timber-framed construction.

Principal risks and guidance

Rain penetration

There can be an increased risk of rain penetration if a cavity is fully filled with insulation, ie moisture is able to transfer from the outer to the inner leaves resulting in areas of dampness on internal finishes. Rainwater, under certain driving rain conditions, can penetrate the outer leaf of masonry leading to wetting of the cavity insulation, a reduced thermal performance and damage to internal finishes. The ability of the insulated wall to resist this transfer of moisture is influenced by:

- | the location of the wall and its exposure to wind-driven rain,
- | the type and effectiveness of external protection or cladding, (render, rainscreen cladding, decorative/protective coating),
- | the quality of design, specification and finished workmanship,
- | the maintenance attitude to the upkeep or improvement of the previous two points.

However, this risk of rain penetration is likely to reduce as the insulation thickness is increased. The insulation will ultimately reach



Mortar extrusions into a fully filled cavity can lead to rain crossing to the inner leaf

Insulating solid masonry walls

GBG 50

Charles Stirling

BRE Scotland

Solid masonry walling was the accepted form of wall construction until it was superseded in the early 1900s by twin-leaf (cavity) masonry construction and recently lightweight framed construction. However, solid masonry construction is estimated to represent some 15% of the existing domestic

stock, a considerable number of dwellings which could be thermally upgraded. Additionally, the increased levels of insulation proposed by building regulations may present, in some instances, technical challenges to cavity and framed construction. In these cases, it may be

appropriate to consider specifying solid masonry construction for new build. The objective of this *Good Building Guide* is to highlight some of the risks associated with solid masonry walling and to provide solutions for improving the thermal performance of this construction form.

Solid masonry construction

Although not a common form of modern building construction, solid masonry walling makes up a sizeable proportion of the current housing stock. Most examples are of low-rise (two-storey) detached, semi-detached or terraced construction. However, in the post-war era a number of multi-storey buildings were constructed using solid masonry infill panels supported on concrete floor decks.

Historically, by far the most common material used in solid masonry walling around the late 1800s and early 1900s was clay brickwork, nominally 230 mm thick. However, a range of masonry materials and thicknesses have been used including stone, in-situ cast dense and no-fines concrete and lightweight concrete blockwork. Some of these materials may present their own technical and buildability issues when considering thermal upgrading. Consideration will need to be given where a building has listed status or where there may be problems in achieving appropriate fixing or adhesion to the masonry substrate.

From a through-life performance perspective, solid masonry walling can provide



External refurbishment of (a) low-rise and (b) medium-rise buildings

Providing temporary support during work on openings in external walls

To minimise any risk of structural movement or collapse, care is needed in the selection and positioning of temporary support for works to openings in external walls. This guide shows how to provide temporary support for walls, floors and roofs when replacing lintels or creating or enlarging openings. **Before starting work you must first check the size of load which will bear on the temporary support; a simplified method for assessing load is given in GBG 10.**

The guidance applies only to traditional housing of solid or cavity brick or brick/block wall construction, with wooden floors and typical pitched purlin roofs. Separate guidance will be published on temporary support for trussed rafter roofs. More detailed advice on loading and method of support will be needed if the existing construction is in poor condition.

Contents

- Checks before starting work page 2
- Typical lintel replacement sequence page 3
- Materials page 4
- Good propping practice page 4
- Ensuring a sound base for the props page 5
- Supporting floors page 6
- Supporting purlin roofs page 6
- Supporting wall loads page 7
- Safety and further information page 8

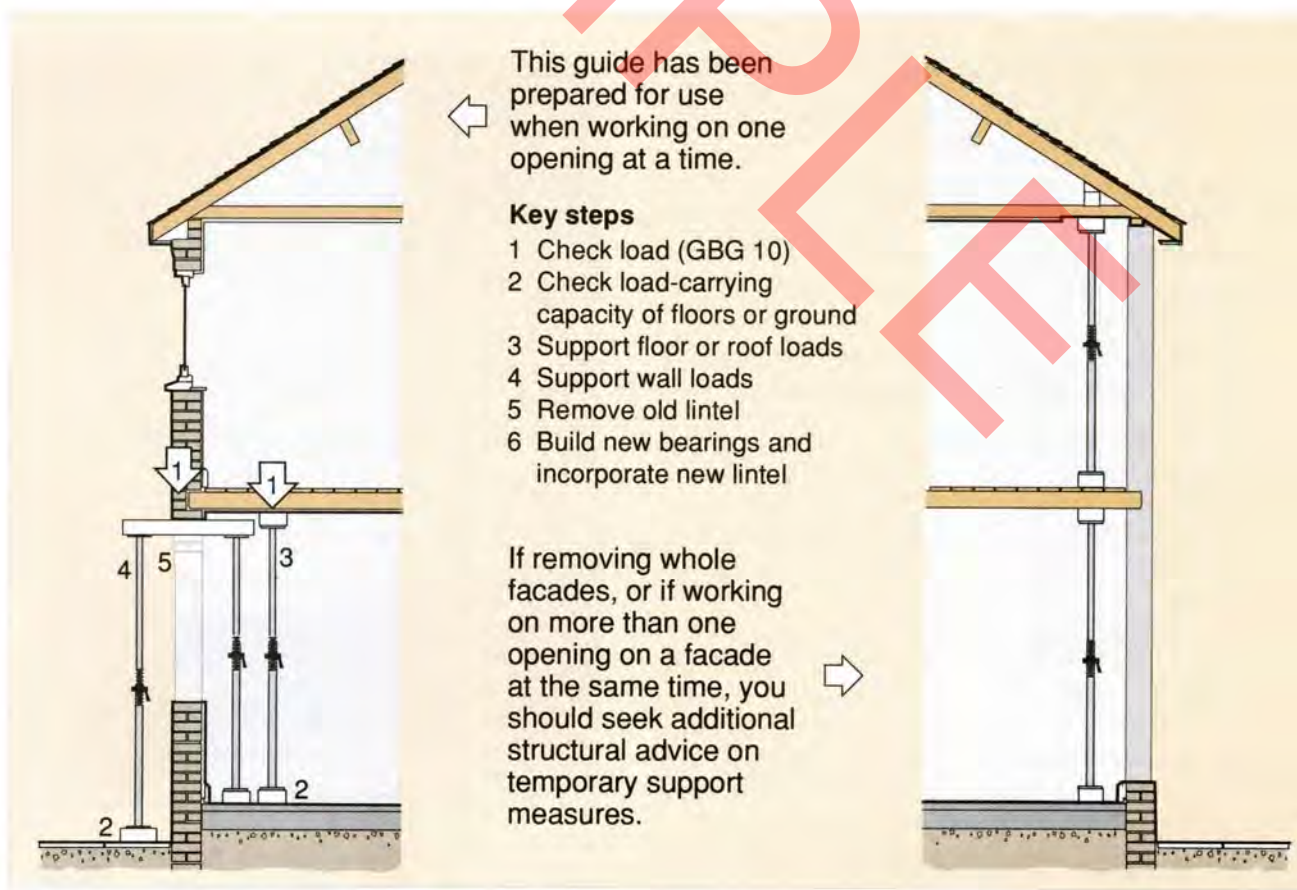

Removing internal loadbearing walls in older dwellings

GBG 20

A common alteration to older properties is the creation of an open-plan ground floor by removing part of an internal loadbearing wall.

This guide is aimed at those responsible for specifying, carrying out and inspecting such alterations. The work must be specified

by a chartered structural engineer, or other suitably qualified person, and carried out by a builder with the relevant experience.

REMEMBER !

If you are considering the removal of a loadbearing wall, you must consult a chartered structural engineer, or similarly qualified person.

This guide applies to traditional two or three-storey, terraced or semi-detached Georgian, Victorian, Edwardian or pre Second World War houses with masonry or timber loadbearing internal walls, timber floors and typical pitched purlin roofs. It does not apply if the wall is a separating wall between dwellings.

Guidance is provided on the assessment of the property to ensure that the alteration can be carried out safely and, on completion, will be structurally sound.

Advice is given on temporary support, the extent to which demolition may be possible, and what permanent strengthening of the structure or the foundations may be needed to accept redistribution of the load.

Since such alterations are structural changes, they are subject to Building Regulations control. Full plans and calculations, or a Building Notice, must be submitted to the Local Authority Building Control Department or an Approved Inspector.

A typical ground floor plan (below left) where 'knocking through' might be considered and a spacious living area (below right) created by a careful alteration

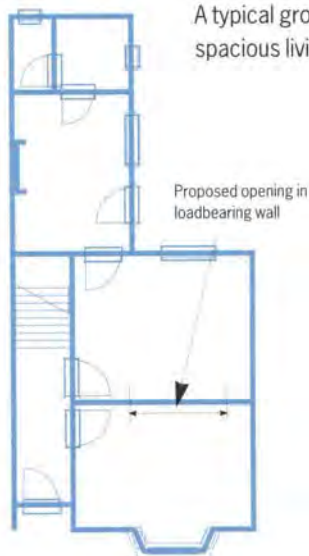

Repairing brick and block freestanding walls

Many freestanding walls have been in service for decades or even centuries and are still an attractive and practical feature of town and country landscapes. But if these walls are not well built to start with, they can fail early in their life. And if the local conditions change (eg the exposure is

increased when neighbouring buildings are demolished or a nearby tree grows too big) a well-established, soundly built wall can be damaged or can even collapse completely. Before starting on any repair, whether a minor patching up or a major rebuilding, it is important

to find out what caused the problem. Failure to do that can easily lead to a recurrence. This Guide aims to help in assessing the damage in freestanding masonry walls, establishing the cause, and carrying out an effective repair. It does not cover parapets or walls built as retaining walls.

Assessing a damaged wall

Collapses of freestanding walls cause a number of deaths and injuries so the first thing to do is to make the wall safe if you think it may pose a danger to the public (see Box, right).

After checking the safety of the wall, find out about the wall's history and its environment.

- l Who owns the wall? This is not always straightforward. Who has the authority to commission repairs?
- l When was the wall built? Have there been any changes in the surrounding buildings, ground levels or underground services? Could the damage be due to nearby trees?
- l Are there similar defects in any walls in the neighbourhood? What are the local practices and what materials have they used? Are there any conservation or heritage requirements?

The next step is to look at the wall to see if there are any obvious defects in its design and construction that may have led to the damage and which will determine whether the wall needs to be knocked down and rebuilt or whether it can be repaired.

Ensuring the safety of freestanding walls

- l Prop the wall and contact the local authority if you are in any doubt as to its structural integrity.
- l Remove any parts which could fall onto people, animals or traffic.
- l Check whether piers supporting gates are sound and strong enough for the job, and whether they are correctly bonded to the wall.



Before tackling any repair, it is vital to find out the cause of the damage

Repairing chimneys and parapets

Good Repair Guide 15

good repair guide

Chimneys and parapets are more exposed than any other part of a building, and wind, frost, rain and sun take their toll on all the materials. If they are allowed to get into a bad state of repair, rain can penetrate to the inside of

the building. Falls of masonry from unstable chimneys and parapets pose real danger to people below.

It is vital that repairs are carried out to a high standard and that bricks and mortar, and concrete

and metal components, are carefully selected to ensure they are durable in severe exposure.

This *Good Repair Guide* deals with how to make damaged chimneys and parapets safe and weathertight.



Condensation leading to sulfate attack has caused twisting and leaning of the stacks

Good Repair Guide 14 gave some advice on recovering a pitched roof. This *Good Repair Guide* deals with two related problems at roof level: how to make damaged chimneys and parapets safe and weathertight. Ideally, chimneys and parapets should be worked on at the same time as the roof, to minimise the risk of damage to roof coverings, and cut down any scaffolding costs.

Chimneys and parapets are more exposed than any other part of a building, and wind, frost, rain and sun take their toll on all the materials. If they are allowed to get into a bad state of repair, rain can penetrate to the inside of the building. Falls of masonry from unstable chimneys and parapets pose real danger to people below; this type of fall causes a high proportion of the deaths and injuries that occur round buildings.

It is vital that repairs are carried out to a high standard and that bricks and mortar, and concrete and metal components, are carefully selected to ensure they are durable in severe exposure.

These high standards are likely to mean that the job will be more expensive than standard brickwork repairs.

Repairing damage to brick and block walls

Good Repair Guide 3

Brick and block masonry suffers damage from a variety of causes, not all of which require immediate or extensive attention. This Guide helps anyone carrying out these repairs

to choose the appropriate method for any given situation. It emphasises the importance of assessing the structural stability of damaged walls.

good repair
 guide

The first thing to do...

...is to work out what *caused* the damage. This is the only way to make sure that your repairs will be effective. For example, cracking is the commonest type of damage to masonry, but until you have identified which of the various possible causes is responsible (see opposite), you can't tell whether it will be enough simply to repair the cracks. Has the damage to the wall made it unstable? – you must answer this question before you start work, because the answer largely determines what repair work is necessary and when it can be safely done (see page 2).

Householders need to remember that, if they intend to make an insurance claim on damaged masonry, the insurance company should be informed **when the damage is first observed**.

Safety warning!

If there is any doubt about the structural stability of a building, seek professional advice immediately.

The likely causes of damage

- | Ground movement: can cause walls to crack.
- | Thermal movement: changes in temperature can set up stresses sufficient to fracture or distort a wall, especially if the wall is exposed to the weather.
- | Drying shrinkage: confined mainly to concrete and calcium silicate brickwork and blockwork. It is most likely to occur around window and door openings.
- | Roof spread: pitched roofs that have not been properly tied will 'spread' at the eaves, distorting and damaging the top of the walls. Potentially a very serious problem.
- | Sulfate attack on cement-based mortars: occurs when the water-soluble sulfate is able to penetrate steadily into mortar held in a predominantly wet condition.
- | Moisture expansion: damage caused by clay bricks expanding usually take places quite early in the life of a building, but where the masonry is very well restrained, stress can build up for 10 years or more before damage occurs.
- | Corrosion of embedded iron and steel: causes opening of masonry joints, cracking and rust staining.
- | Unsound materials.
- | Frost damage: usually confined to unprotected, partly-built masonry or masonry severely exposed to the weather, eg free-standing walls, parapets and retaining walls. Most common cause is wrong designation of brick.
- | Salts: efflorescence is harmless, but crystallisation of salts within the bricks can cause spalling and disintegration of the surface.
- | Fire.

Replacing masonry wall ties

Good Repair Guide 4

Distress of cavity walls is sometimes attributable to corrosion or absence of the metal ties. Generally the wall bulges, cracks or leaks, but if subjected to high wind loads it might even collapse. BRE research has shown that steel ties made before 1981 could corrode prematurely. This means that wall tie corrosion is a

very widespread defect, potentially affecting about 10 million UK dwellings.

Tying problems make dwellings less weathertight and more unstable, and although there is rarely an immediate threat to the safety of the occupants, substantial tie failure can also be a hazard to passers-by, especially when it affects high gables

or multi-storey brick-clad buildings. It is therefore important to inspect the building during maintenance — even if there are no visible signs of tie failure — and when there are other reasons for concern, eg if ties have failed on a similar building, or there is evidence that sub-standard or too few ties may have been used.

What to look for

Cracks in the bed joints

- | A horizontal crack in the external wall or parallel cracks 300–450 mm apart, most commonly visible just below eaves level or below openings.
- | Spalling of thickened joints in fair-faced brickwork (the problem may have been disguised by repointing). There may be some associated vertical or diagonal cracking.
- | Rain penetration or cracking of the inner leaf. Cracking is only likely to happen in areas of the inner leaf which are wet or damp for long periods or where the inner leaf has been disturbed by movement of the outer leaf.

Bulging or movement of the walls

- | Visible lifting of the verge of the roof.
- | Bulging of the wall: corrosion of strip ties causes the outer leaf to expand and so take more of the roof's weight (normally supported on the inner leaf).
- | Cracking at the junction of a dividing wall and an inner leaf displaced by expansion or by connection to an expanding outer leaf.



Horizontal cracking of painted fair-faced brickwork



Spalling of thickened joints in fair-faced brickwork



Lifting of the roof edge (verge) by an expanding gable end



Bulging outer leaf

Repointing external brickwork walls

In rehabilitation work, and occasionally in relatively new properties, brickwork is sometimes found to be in poor condition: the mortar is powdery and easily rubbed away or eroding so that the joints have become

appreciably recessed. The builder has to decide whether there is any loss of strength in the wall and, if there is, if repointing will adequately restore that strength and make the joints sufficiently durable.

It is important to ensure that the mortar is not stronger than the brick. This Good Repair Guide gives advice to builders and householders on choosing the right mortar mix and how to repoint.



Repointing has restored weathertightness to the house on the left



Mortar joints around downpipe have eroded and repointing has been inadequate

Retro-installation of bed joint reinforcement in masonry

GBG 62

Bob de Vekey

BRE Construction Division

Bed joint reinforcement, added during construction, is an accepted technique for making masonry (brick, block and stonework) walls tougher, stronger in flexure and tension, and less likely to crack. It is also used with the masonry to generate lintels (beams) within walls. In its traditional form of either 'hoop iron' or mild steel with only limited corrosion protection (galvanising or bitumen) it has a finite life and is expensive to treat or remove. However, austenitic stainless steel (ASS) versions are very durable and are now used widely, particularly for crack control. For about a decade, the industry has been developing methods for installing bed joint reinforcement into existing walls, ie 'retro-reinforcement'. This allows the product to be used for crack repair (stitching), repairing sagging lintels and flat arches, developing arches or cantilevers within a wall to span over patches of subsidence, increasing the flexural strength (out of plane) and shear resistance of walls to combat wind and seismic loading, and reconnecting cracked or parted buttresses.



Retro-installation of bed joint reinforcement could be applied to these shrinkage cracks and the dropped flat arch

How retro-reinforcement is done

Brickwork techniques

Brickwork has the characteristics listed in Box 1. In such circumstances, the most obvious technique is shown in Figure 1 on page 2.

Where the wall is the external leaf of a cavity wall with only dead loads from masonry above, the slots can be quite extensive with little structural risk as the vertical load is modest and the ties provide lateral restraint. However, some temporary propping, packing or jacking may be

required in advance of the slot formation in cases where walls have locally subsided and have opened up either horizontal or angled cracks, especially those around openings.

Blockwork techniques

Blockwork and some stonework commonly has the characteristics listed in Box 2.

Obviously, the 'brickwork' technique can be used, where feasible. However, it is commonly as easy to determine the required slot frequency by structural calculation and to slot the masonry as

Box 1 Characteristics of brickwork

- Most bricks are fairly strong hard materials.
- They are normally in thin regular layers of no more than 75 mm thickness with a 10 ± 2 mm mortar joint between each layer.
- They are frequently, though not invariably, fairfaced and constitute the finish of the building.
- They are the strongest and most durable component of the wall.
- In the external leaf of a cavity wall dead loads from higher levels of brickwork are the only significant load.

Box 2 Characteristics of blockwork

- The units vary from relatively soft, easily worked to fairly hard materials.
- Regular layers, if present, are commonly 215 mm thick with a 10–15 mm mortar joint.
- Walls built from rubble, partly coursed stonework, ashlar stonework, etc. may have either a very rough plane joint or no continuous horizontal joint at all.
- The walls may be fairfaced but commonly will be rendered over, thus making it difficult to discern the mortar joints.

Supporting temporary openings

Good Repair Guide 25

good repair
guide

Forming a new opening in a loadbearing wall or enlarging an existing opening are both quite common operations for builders involved in alteration work. But it can

be difficult to decide how much temporary support is needed while the work is done, and to make sure it is properly installed and safe. This Good Repair Guide gives advice on how to

provide safe support when creating or enlarging openings or replacing lintels in traditional buildings.



This new door is being fitted without any temporary support to the brickwork above — it could be an expensive mistake

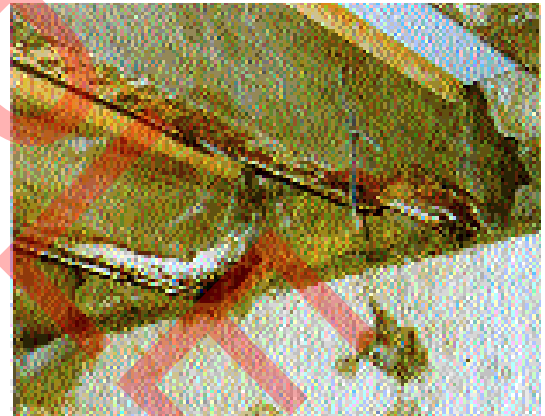

This floor would not be a sound base for loads from temporary supports

If a structure moves during alteration work, it could be dangerous and at the very least it is likely to be expensive. This *Guide* summarises the important steps to take, both before and during alterations, to prevent this happening. It describes how to provide temporary support for walls, floors and roofs when creating or enlarging openings or replacing lintels.

The advice applies to traditional low-rise construction of solid or cavity brick or brick/block wall construction, with wooden

floors and typical, pitched purlin roofs; it does not cover trussed rafter roofs. It deals mainly with openings in external walls, but similar guidance applies to removing part of an internal loadbearing wall (see box, page 4). There is more detailed information on both operations in the BRE leaflets listed in *More advice!* on page 4. The advice of a chartered structural engineer or other similarly qualified expert should be sought for all alterations of the kind described here.

BRE

Surveying brick or blockwork freestanding walls

Freestanding masonry walls are exposed to the weather and wind loading on both faces. If only a small part of a wall is unstable progressive collapse of the whole wall can occur, with a risk of serious injury to people. When surveying freestanding walls it is essential to identify all factors which might affect performance and any faults or damage which could lead to collapse. This Guide provides a checklist for assessing freestanding masonry walls and indicates when repair or rebuilding is needed. It does not deal with parapet or retaining walls. Information on repairing walls will be published in a future Guide.



Cracks on or near piers will require urgent attention

Background

The chart below sets out the key considerations which should be kept in mind when surveying freestanding walls. As a general rule walls built with cement mortar are more rigid than older walls constructed using gauged mortar with hydraulic lime. For this reason older walls may be more tolerant of movement and less liable to collapse in large sections.

A wall must be structurally stable and resistant to any **wind loads** which might be imposed in service or collapse could occur.

Walls are exposed to driving rain on both faces and very susceptible to frost damage; they must be built of **frost resistant** materials.

To minimise rain penetration through the top of the wall, **cappings or copings** must be firmly fixed and built to shed water away from the wall.

Changes such as **new openings** must not increase wall loadings or reduce stability.

During the life of a wall, if **changes** are made **to the ground level** on one side of the wall, this may increase loadings and reduce stability.

Changes to nearby buildings may increase exposure to weather. **Changes in vehicle access** may increase the risk of impact damage.

Mature trees may damage foundations. Some **climbing plants** can damage mortar.

Surveying masonry chimneys for repair or rebuilding

CI/SfB (28.8) (A3s) (W7)

CAWS C40

During the life of a building, chimneys may need repair, be required to act as flues for different fuels or appliances, or become redundant. This Guide shows what to look for when assessing chimneys for repair, reuse or decommissioning. Advice on how to carry out recommended work will be published in a separate Good Building Guide.



A common problem with chimneys - condensation leading to sulphate attack and causing twisting and leaning of stacks

Background

The following chart shows the key performance considerations which apply to chimneys. For each, the survey should identify any shortfalls in performance or any signs of deterioration which might soon lead to inadequate performance.

Structural

The chimney must be structurally stable and wind resistant.

Durability

It must be constructed of long-lived materials, resistant to exposure and degradation.

Operation

The chimney must be designed and built to give a good updraught and ensure complete combustion and passage of combustion products to the outside.

Weathertightness

Rain must be prevented from penetrating the chimney or the building.

Health and safety

The chimney should not constitute a fire hazard; fuel gases and smoke should not enter the building.

Condensation

This occurs in the flue, particularly when cold and if the flue gases cool down. The flue should be constructed to prevent condensate damaging the chimney structure.

Temporary support: assessing loads above openings in external walls

CI/SfB (21) (B2)

CAWS C40

Second Edition

Many buildings require minor structural alteration or repair around openings during the course of their life. Others may require enlarged or new openings. Because loads above openings can vary considerably, care is needed to provide sufficient temporary support during these operations. BRE site surveys reveal that loads above openings are often seriously underestimated, leading to inadequate temporary support and a risk of structural movement or even partial collapse during works. For surveyors and builders this guide gives a simple procedure

for assessing loads above lintels in traditionally-built brick or brick and block housing up to three storeys. *This edition has been amended to allow greater accuracy in the estimation of wall and roof loads, and is now complemented by GBG 15 which gives guidance on appropriate temporary support measures. Where there is doubt about the nature of the construction or if unusual loads are suspected, specific structural advice should be obtained. Guidance on whether or not lintels require replacement is given in GBG 1.*

Why it is important to assess load

When repairing or altering openings, removal of the existing lintel is often necessary. Before starting work it is essential to establish the construction and assess the loads which bear at the lintel level. In some cases the construction bearing on the lintel (shaded) may require only minimal temporary support during works (below left), but sometimes major loads must be carried (right).

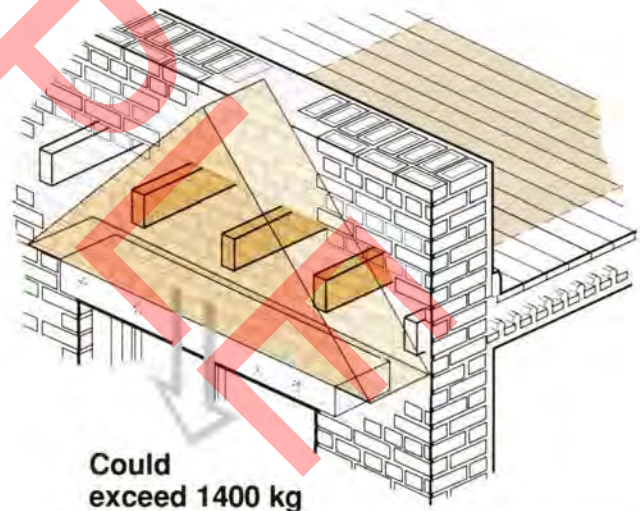

Loading terms used in this guide

The **working span** is the length of the original or replacement lintel (whichever is the longer) plus an allowance (one full brick at each end of the lintel) for removing or placing a lintel.

The **load triangle** (dark grey) is a triangle of wall with a base length equal to the working span and with base angles of 45° . All the masonry within the load triangle (and all other loads supported on this masonry) must be included in loading estimates.

The **interaction zone** (light grey area) is a chevron shape outside the load triangle with outer angles of 60° . Roof or floor loads bearing in this zone must be included in loading estimates.

The **application level** (coloured line) is a line level with the uppermost bearing surface of the lintel.

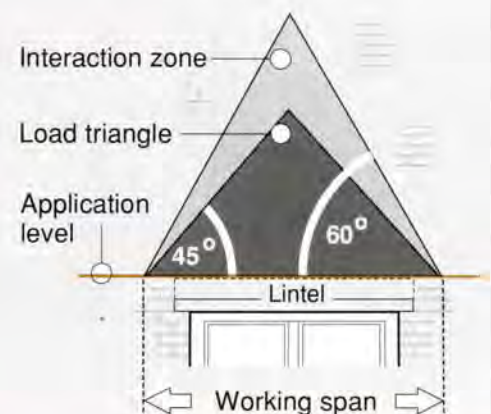

Bob de Vekey

BRE Construction Division

Since the 1940s, social, political, technical and market forces have been at work to reduce the market share for masonry in construction. Thin layer mortar technology, which is rapidly gaining in popularity among UK builders, overcomes many of the actual and perceived disadvantages of conventional masonry techniques.

Thin layer mortar is easy to mix on site, adding only water. The laying technique is simple and fast using large accurately sized block units and less mortar. The result is increased productivity and savings in labour and materials.

Thin layer mortar technology complying with building regulations and relevant codes of practice aims to retain masonry as a preferred option for house construction where its proven durability, inherent fire resistance, good noise exclusion and low maintenance make it one of the best choices for owners.



Figure 1
Courtesy of AACPA

For two decades a new technology for bonding masonry has been under development termed ‘thin layer’, ‘thin joint’ or ‘thin bed’ mortar. Currently, the preferred English term, used in the British Standard BS EN 998-2: 2002, is ‘thin layer’ which will be used in this *Good Building Guide*.

Much of the earlier development was in continental Europe in the construction of rendered solid masonry using large calcium silicate, clay or aircrete (autoclaved aerated concrete or AAC) blocks. It is quickly gaining popularity with UK builders especially for aircrete blockwork used in solid wall systems or in the loadbearing inner leaf of brick/block cavity walls.

What is thin layer mortar?

Thin layer mortar is a polymer-modified cement-based fine-grain mortar supplied as a ready-to-use powder that is mixed with water using a standard plasterer’s whisk attachment in an electric drill. This produces a smooth, free-flowing adhesive compound with some thixotropic behaviour (ie it flows when worked but stiffens when left alone)

that can be applied to masonry units using a ‘scoop’ which is a proprietary spreading tool with a serrated edge (see Figure 5) or may be delivered via pipes and nozzles. The mortar has a good pot life and retains its flow characteristics for several minutes after being applied to a masonry unit, allowing time for positioning, levelling, etc.

Finally, it sets rapidly with some suction after full contact between units and has developed sufficient strength within minutes to resist minor disturbance and a substantial fraction of its ultimate strength after about an hour.

The benefits of thin layer mortar technology are summarised in Table 1.

Materials and tools

Box 1 lists what you need for the successful application of thin layer systems.

Mortars

Most of the manufacturers of units (blocks) that manufacture to the required tolerance either

Roofs and roofing

Roofs and roofing

Bracing trussed rafter roofs	GG 8
Building a new felted flat roof	GG 36
Erecting, fixing and strapping trussed rafter roofs	GG 16
Flat roofs: assessing and making roof repairs Part 1: Assessing bitumen felt and mastic asphalt for roof repair	GR 16-1
Flat roofs: assessing and making roof repairs	GR 16-2
Insulated profiled metal roofs	GG 43
Insulating roofs at rafter level: sarking insulation	GG 37
Loft conversion: Part 1. Structural considerations	GG 69-1
Loft conversion: Part 2. Safety, insulation and services	GG 69-2
Recovering pitched roofs	GG 14
Site-cut pitched timber roofs: Part 1. Design	GG 52-1
Site-cut pitched timber roofs: Part 2. Construction	GG 52-2
Tiling and slating pitched roofs: Design criteria, underlays and battens	GG 64-1
Tiling and slating pitched roofs: Plain and profiled clay and concrete tiles	GG 64-2
Tiling and slating pitched roofs: Natural and manmade slates	GG 64-3
Ventilated and unventilated cold pitched roofs	GG 51
Ventilating thatched roofs	GG 32

Bracing trussed rafter roofs

CI/SfB (E7) i2 (27.9)
CAWS G20

Trussed rafters must be braced to create a rigid and stable roof structure. If this bracing is omitted, wrongly positioned or badly fixed, it can result in distortion or failure of individual trusses or in some instances of the whole roof.

This guide, for supervisors on site and building inspectors, shows how to install timber bracing in typical trussed rafter roofs of up to 12 m span.

It gives guidance on materials, and on where and how to fix the bracing *normally* required for dual- and mono-pitched roofs. On some roofs the normal bracing arrangements are not appropriate and in these cases it is important to follow carefully the roof designer's specification for positioning and number of braces. Future guides (page 6) will cover other practical aspects of trussed rafter roof construction.

Why bracing is important

Stability

In service, some trussed rafter members are under compression from **dead loads** (tiles, felt, battens) and from **imposed loads** (eg snow). These loads can cause buckling in unbraced or poorly braced roofs. Buckling can occur across the whole roof, resulting in displacement of tiles and oversailing/disappearance of the verge at the gables. Roof buckling may result in unacceptable loads being transmitted to the gable and to reduced weathertightness of the tile layer. Three types of **stability bracing** are required to resist buckling:

- diagonal rafter bracing (page 3)
- longitudinal bracing (page 4)
- chevron bracing (page 5), on spans over 8 m.

The interaction between the three types of bracing is complex, with tiling battens and plasterboard also contributing to overall rigidity.

Wind resistance

A trussed rafter roof must also be able to resist **wind loads**, particularly pressure and suction forces at the gables and any rotational effects generated by wind at an angle to the roof. Stability bracing, together with the specified gable wall fixing straps, create a rigid roof/gable structure which will be resistant to normal design wind loads. In very exposed locations, the roof designer may have specified additional wind-resisting measures, for example additional bracing or larger dimension bracing timbers.



Dead and imposed loads...



...can cause unbraced rafters to buckle.



Inadequate bracing can lead to buckling of rafters across the whole roof.

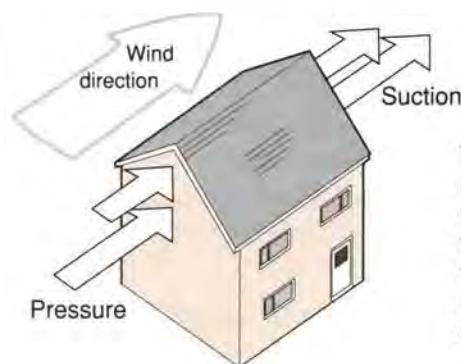

To achieve a wind-resistant roof and gable structure, the roof must be fully braced *and* strapped to the gables.

Building a new felted flat roof

GBG 36

In recent years there have been big advances in materials and design choices for flat roofs so weathertightness and energy performance of modern flat roofs has

improved. This Good Building Guide focuses on one of the commonest examples of a new flat roofed building — an extension built onto an existing house. Here a flat

roof may be the only practical option, and may also be the cheapest. This Good Building Guide advises on how to make a good job of a new felted roof extension.



Laying a vapour control layer in hot bitumen over a chipboard deck — the first stage in a warm-deck roof



Laying polyisocyanurate boards to create a warm-deck roof

Not so long ago flat roofs were a byword for trouble, and there was a common saying that the only reliable way of dealing with a problem flat roof was to build a pitched one over the top. But in recent years there have been big advances in materials and design choices, and the record of modern flat roofs has improved.

Nevertheless, there are still plenty of pitfalls for the unwary builder, particularly in the detailing. This Good Building Guide discusses how to avoid these and to achieve a flat roof

that is weathertight, free from condensation problems, and without the high maintenance costs that can occur.

Key design points

As with any roof, a flat roof must protect the occupants and the building structure from the weather, and minimise heat loss from the building.

The main cause of trouble in small domestic flat roofs is water, either due to rainwater

Erecting, fixing and strapping trussed rafter roofs

Careful erection, fixing and strapping is essential if a trussed rafter roof is to provide a sound platform for roof coverings and contribute effectively to the stability of the roof and gable ends. This guide, for site supervisors and building inspectors shows the normal arrangements for fixing and strapping of domestic roofs up to 12 m span.

It indicates the tolerances which can be allowed during erection and how metal straps should be fitted to ensure that roof and walls act together to form a stable structure. Good Building Guide 16 should be used alongside GBG 8, which gives guidance on the stability bracing needed between the trussed rafters themselves.

Why careful fixing and strapping is important

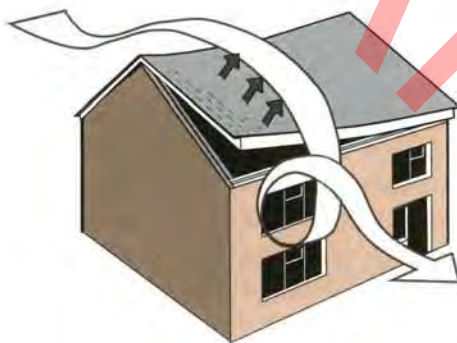

To resist uplift by wind suction, lighter roofs or roofs in exposed locations should be firmly fixed to the wall plate and may need to be strapped down to the wall structure.



If not firmly strapped to a well-braced roof, gables may be vulnerable to wind pressure, in particular suction forces which may pull gables outwards.

Checks before erecting trussed rafters

- The cavity is closed along the eaves line (either stopped with masonry or a cavity barrier).
- Wall plate is minimum 75 mm x 50 mm.
- Timber members and connector plates are not damaged and are of the correct size.
- Trussed rafters are the correct span and can be fitted to wall plates **without cutting**.
- Timber is dry and sound, and the connector plates free of corrosion.
- There are no missing connector plates.
- None of the trussed rafters are visibly distorted (see page 3)
- There is no evidence of unapproved site repairs to trussed rafters. Repairs must be carried out only under the direction of the truss designer.
- Positions for water tank and for chimney and access openings are clearly identified and detailed.
- Clear guidance is given on the number, size and corrosion resistance of straps, clips and fixings.

Flat roofs:

assessing bitumen felt and mastic asphalt roofs for repair

Good Repair Guide 16

Part 1

Most flat roof coverings need repair or replacement during the life of the building. This can be anything from a small patch repair to renewal of

the roof covering or even rebuilding the whole roof structure. Part 1 of this Guide gives advice on how to carry out a detailed assessment of

bitumen felt and mastic asphalt roofs in need of repair or refurbishment. Part 2 gives guidance on how to plan and carry out remedial work.

Other parts to this Guide

For making repairs – see Part 2

Before embarking on any work on a flat roof, it is essential to carry out a careful and detailed assessment of its condition. There is no point in carrying out piecemeal repairs to the membrane if there are serious problems in the roof structure. On the other hand, many sound roofs are renewed completely when a repair would have been perfectly adequate.



The first thing to do...

...is to find out about the roof's history.

History-taking for a flat roof

- | How old is the covering?
- | Has the covering been repaired before?
- | For how long has the roof been defective?
- | If the roof is leaking, does it leak during or immediately after rainfall? or a few days later?
- | Does water pond on the roof?
- | What is the room below used for? (Flat roofs above kitchens, utility rooms or bathrooms are more vulnerable to condensation problems than those above living rooms or garages.)
- | Are there any plans for a change of use?
- | Is the roof used as a balcony or terrace? or are there plans to use it as such?

Visual inspection

The next step is to make a thorough visual inspection, both outside and inside the building. Before getting up on the roof, make sure it is safe to do so. For instance, if the roof is sagging between the joists, don't walk on it. If possible, do your inspection during and immediately after rainfall so that you can see any ponding or leaks and watch the speed of drainage. A checklist for the inspection is given in the box on page 2.

Flat roofs: making repairs to bitumen felt and mastic asphalt roofs

Good Repair Guide 16

Part 2

Choosing the right method of repair for a defective flat roof is as important as choosing the right roofing system in the first place. In many ways, repair probably calls for a greater level of skill than starting

from scratch because there is no standard solution — each roof must be treated as an individual problem. Repairs to a flat roof can mean anything from a patch to total replacement.

Part 1 of this Guide gives advice on how to carry out a detailed assessment of a roof in need of repair or refurbishment. Part 2 advises on how to repair defective bitumen felt and mastic asphalt flat roofs.

Other parts to this Guide

For assessing what repairs need to be made – see Part 1



Many sound roofs are renewed when a repair would be sufficient — and there are many excellent techniques and products available to make minor repairs. Patch repairs of the covering can also allow time to organise re-roofing at the right time of year. But repairs are worthwhile only if they are cheaper than the effective cost per year of a new roof covering. If the problems are due to normal ageing, or to

bad design, materials or workmanship, it makes sense to re-roof. It also gives an opportunity to improve the roof's performance.

The first essential is to find out the cause of failure; this was discussed in *Part 1*. This *Part* considers the various levels of repair that could be needed and the most appropriate remedies for both bitumen felt and mastic asphalt roof coverings.

Insulated profiled metal roofing

GBG 43

Charles Stirling

BRE East Kilbride

Profiled metal sheeting has been used for domestic roofs and, more commonly, in commercial and industrial buildings for many years. As with other thermally responsive construction, when elements having a high resistance to water vapour

are incorporated there is a potential risk of condensation, which can be increased if thicker insulation is used. Condensation can reduce the thermal performance of the roof and cause disruption to internal finishes.

This Good Building Guide highlights typical profiled metal roof constructions, some of the technical risks associated with increased levels of insulation and the design aspects which should be considered.

Technical risks

The principal technical risks result from increased thickness of insulation which can result in:

- | thermal bridging, where thermally conductive metal components penetrate the insulation layer resulting in localised cold spots on the inner surface and the possibility of surface condensation,
- | condensation forming on the underside of the outer sheet due to cooling resulting from radiation to the cold night sky,
- | thermal movement of the outer skin due to wider temperature variation.

Typical assemblies

Profiled steel or aluminium sheets are used in a number of assemblies as follows.

Single skin

An uninsulated profiled sheet is fixed directly to the purlins (Figure 1). This form of construction is generally used only over storage buildings, warehouses, animal housing and uninhabited buildings or as canopies over workspaces. However, uninsulated single skin

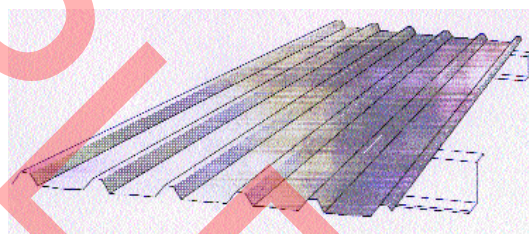

Figure 1 Single skin

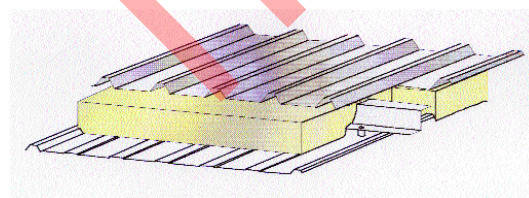

Figure 2 Double skin

sheets can be laid over horizontal insulation or existing insulated flat roofs. In these situations the risks and considerations which apply to the insulated roof systems below should be considered.

Insulating roofs at rafter level: sarking insulation

Charles Stirling

BRE Scottish Laboratory

This Guide highlights a system of roof insulation where the insulation material is laid between and over inclined rafters: it is sometimes referred to as sarking insulation. Sarking insulation provides an effective solution to

satisfying the thermal requirements of building regulations. It allows complex roofs to be more effectively insulated with a reduced risk of thermal bridging and condensation problems as the roofing timbers are kept at or near

internal environmental conditions. This Guide provides advice on specifying sarking insulation and on avoiding the associated technical risks.

The enclosed roof space of many buildings is increasingly being utilised as useable or habitable space so that insulation has to be provided along the slope of the roof. The insulation can be placed above, between and below the inclined rafters or a combination of these. Specific guidance is currently available where the insulation is placed solely between rafters. Insulation placed over the rafters is a relatively new technique and as such there is little specific guidance on its use. The advice within this *Good Building Guide* will assist specifiers and builders to reduce the technical risks where the insulation is placed above and between the rafters, as shown in Figure 1 (page 2). This technique has several advantages as follows.

- | Complex roofs, where there are penetrations, hips, valleys, dormers, etc., can be successfully insulated without the difficulties associated with installing ventilation between the rafters.
- | Rafters do not have to be so deep as they do not have to accommodate the full depth of the insulation plus a ventilation space.



With sarking insulation the roof timbers are kept at or near to internal conditions and there is a reduced risk of thermal bridging and condensation

Loft conversion: Structural considerations

GBG 69 Part 1

Loft conversions can provide useful extra living space but can be difficult to design and build. Not all houses are suitable.

This Good Building Guide gives advice on loft conversions in houses not more than two storeys high; Building Regulation (England & Wales) requirements for three or more storeys, particularly for means of escape, are different. The advice applies to loft conversions with no more than two habitable rooms and a maximum floor area of 50 m², and only to dwellings in single occupancy.

Part 1 of this Guide provides information on the suitability of different types of lofts for conversion and the structural considerations, while Part 2 considers other safety requirements, insulation and installation of services.



Converting the space in the roof into habitable rooms has become an increasingly popular way of providing extra space for a growing family, an office or a dependent relative. However, loft conversions call for careful consideration of structural design, layout, fire performance, means of escape, ventilation, insulation and staircase provision. Getting any of these issues wrong could result in serious problems, affecting the durability

and life of the building and the safety of the occupants.

Most of the work will involve normal building practices and be subject to the usual Building Regulations and British Standards. In general, the advice given in this *Good Building Guide* is concerned with issues that arise in loft conversions, not in standard building, and assumes familiarity with general practice.

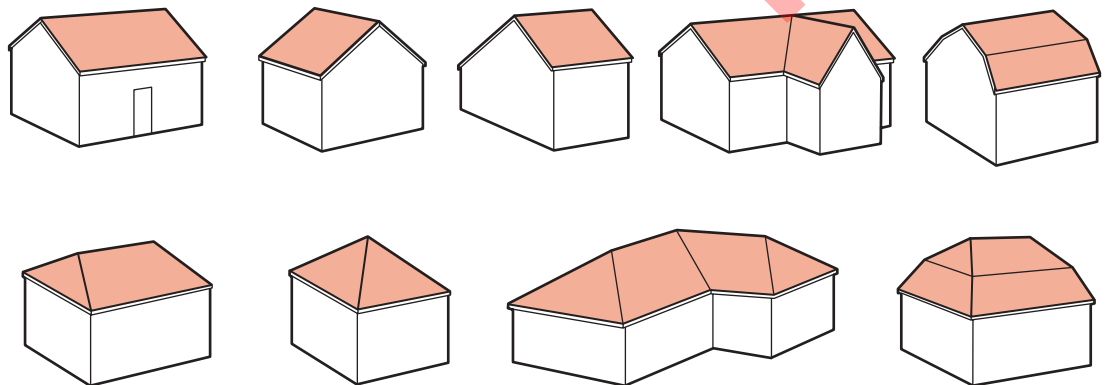

Figure 1 A wide variety of roof shapes may be suitable for loft conversion

Loft conversion: Safety, insulation and services

GBG 69 Part 2

This Good Building Guide gives advice on loft conversions in houses not more than two storeys high; Building Regulation (England & Wales) requirements for three or more storeys, particularly for means of escape, are different. The advice applies to loft conversions with no more than two habitable rooms and a maximum floor area of 50 m², and only to dwellings in single occupancy.

Part 1 of this Guide provides information on the suitability of different types of lofts for conversion and the structural considerations, while Part 2 considers other safety requirements, insulation and installation of services.



Photo courtesy of Velux

Stairs

When the loft is converted into habitable rooms, a fixed stair must be fitted. Non-fixed stairs, such as retractable loft ladders, are only permitted when the space is to be used solely for storage.

Wherever possible, for maximum safety and ease of use, stairs should comply with the usual requirements set out in Approved Document K, which stipulates a maximum pitch of 42° and a minimum headroom of 2 m. If this is not possible in a loft conversion, a minimum headroom of 1.9 m at the centre line is permitted, with a minimum of 1.8 m at the edge of the stair (Figure 1). There must be a minimum clearance of 1.5 m between the pitch line and any bulkhead slope. The rise should be no more than 220 mm and the going (tread less nosing) no less than 220 mm. A good guide is that twice the rise plus the going (2R + G) should be between 550 mm and 700 mm.

There is no minimum requirement for width, but where there will be two new rooms, a width of

800 mm is recommended for ease of moving furniture. If there is only one room, a minimum width of 600 mm is acceptable.

If space is limited, alternative designs of stairs are permitted, provided they give access to only one habitable room. The stairs should have uniform dimensions, two handrails, clearly defined nosings, and goings as large as possible. It

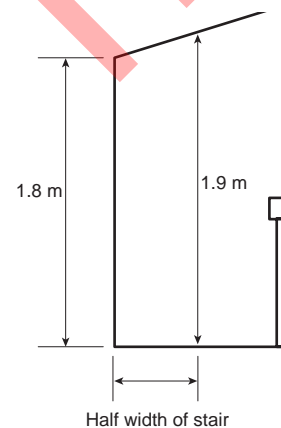

Figure 1 Minimum clearances required above stairs in loft conversions. Modified from Approved Document K

Building simple plan brick or blockwork freestanding walls

May 1994

CI/SfB (90.3) F (D6)

CAWS F10

First revision

All freestanding walls must be stable under wind load and durable under service conditions. For simple plan brick and blockwork walls this guide gives rule of thumb guidance for stable construction. It identifies the rarer situations where local conditions may require that the wall design is checked or prepared by a structural engineer. Guidance is offered on the choice of materials and on the practical details of construction which together contribute to preventing premature wall deterioration.

This guide does not cover stone walls, retaining walls or the construction of freestanding parapet walls on buildings. Good Building Guide 19 gives advice on construction options for taller walls and walls with more complex plan shapes.

Contents

- **Building for stability** pages 2 and 3

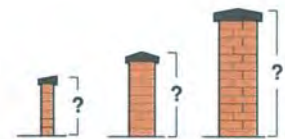

- **Choice of materials** pages 4 and 5

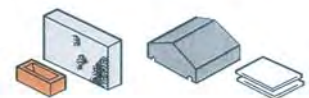

- **Construction guidelines** pages 6 and 7



- **Further information** page 8



A well constructed wall. The height to thickness ratio makes it safe. Good detailing around the capping and a low level dpc will ensure that it is durable.

Site-cut pitched timber roofs: design

GBG 52

Part 1

Pitched roofs can be constructed in several different ways. They can be built in situ with each piece cut and fitted individually, they can use prefabricated or site-made trusses to support in situ fitted purlins and rafters, or they can be built with prefabricated

trussed rafters forming the complete roof structure. Prefabricated roofs have become the most common form of construction in recent years but there are situations where a purpose designed and site-built roof (often referred to as a 'cut' roof) may be preferred.

In Part 1, this guide explains the principles of this type of construction and describes patterns of roof structure and design considerations. Part 2 describes a method of fabricating and constructing a typical domestic site-built roof.

Why choose a cut roof ?

The reasons for using a 'cut' roof can include:

- | In a small building with modest roof spans there may be no requirement to use anything more complex than rafters spanning between the wall plate and a ridge board or a purlin or an adjoining wall in a 'lean-to' construction.
- | It may be easier to match the pitch, height and junction details of an existing roof on site than to make a sufficiently accurate survey to enable prefabricated components to be used.
- | A purpose-designed and site-built roof may be visually preferable if the structure is to remain exposed within the building and/or the ceiling follows the line of the rafters.
- | If the roof shape is complex, so obviating any financial advantage of using prefabricated components.
- | If rooms are incorporated within the roof space it may be more practicable to build the roof on site; prefabricated components for these roofs can be large and heavy and a crane is needed to place them.
- | Where the site is in an isolated location or has difficult access.



Site-cut pitched timber roofs: construction

GBG 52

Part 2

Pitched roofs can be constructed in several different ways. They can be built in situ with each piece cut and fitted individually, they can use prefabricated or site-made trusses to support in situ fitted purlins and rafters, or they can be built with prefabricated

trussed rafters forming the complete roof structure. Prefabricated roofs have become the most common form of construction in recent years but there are situations where a purpose designed and site-built roof (often referred to as a 'cut' roof) may be preferred.

Part 1 of this guide explains the principles of this type of construction and describes patterns of roof structure and design considerations. Part 2 describes a method of fabricating and constructing a typical domestic site-built roof.

Building Regulations

A new roof, whether constructed on a new building or as an addition to an existing one, will generally need approval under Building Regulations; you must, therefore consult the local authority before any work is carried out to check what approval is necessary.

In addition to the structural design, approval usually includes requirements for ventilation, thermal insulation and fire resistance (for habitable roof spaces and external flame spread where the roof is near to the site boundary).

If it is intended to convert the roof space to include accommodation, or to alter the shape of the roof, for example to add or remove gables, hipped ends, dormers, planning approval may also be required. If the building is listed, or in a conservation area,

approval may also be required if it is proposed to change the type of roof tile or slate.

If the roof space is to house water storage tanks, the resulting loads must be dealt with separately, usually by supporting them directly from the walls beneath.



Tiling and slating pitched roofs: Design criteria, underlays and battens

GBG 64 Part 1

Harry Harrison

This 3-part Good Building Guide deals with the upper surfaces of pitched tiled or slated roofing. It concentrates on those aspects of tiling and slating that have been most frequently observed in BRE site investigations of roofing schemes, which could lead to deficiencies in the performance of the completed roof. The objective is to provide practitioners with a summary of the main good practice criteria.

Part 1 covers general principles applicable to all forms of tiling and slating, together with criteria where requirements for ancillary materials and practices are common to both tiles and slates, such as weather resistance and underlay specifications and some aspects of work on site.

Parts 2 and 3 describe battening, nailing and product and material quality requirements for tiles and slates.



Design criteria

Weather resistance

The principle underlying the performance of overlapping units on a pitched roof is that all direct paths from the outer surface to the underside are lapped by the adjacent units. There is little tolerance with the positions of some units (eg interlocking tiles) if performance is to meet expectations, but other units (eg plain tiles) are more tolerant. Also, any damaged or displaced unit which reveals an unprotected joint in the surface below will give a risk of rain penetration with gravity, capillarity or wind providing the mechanisms.

Small units may be either single or double lap. Single lap units are normally larger in size than double lap frequently having been of interlocking edge profiles. However, there are exceptions: pantiles, for example. Provided all units, whether large or small, interlocking or not, are laid to manufacturers' recommendations, there should be little difference in their weathertightness.

About this Good Building Guide

This Good Building Guide covers:

- Clay and concrete interlocking tiles;
- Clay and concrete single-lap plain and double-lap plain tiles;
- Slates;
- Tilestones;
- In fact, everything above and between the bare rafters, including appropriate boarded and sheet sarkings, underlays, thermal insulation boarding in warm roofs, ventilation requirements between underlays and tiles or slates, battens, fixing and clipping, mortar bedding, verges, eaves and abutments, ventilated and fully bedded ridges.

This Good Building Guide does not cover:

- Peg-tiles (nowadays used only in restoration work);
- Bitumen felt shingles;
- Wood shingles;
- Metal tiles;
- Thatch.

For guidance on these topics and other aspects of roofs, see BRE's reference work *Roofs and roofing* (BR 302).

Tiling and slating pitched roofs: Plain and profiled clay and concrete tiles

GBG 64 Part 2

Harry Harrison

This 3-part Good Building Guide deals with the upper surfaces of pitched tiled or slated roofing. It concentrates on those aspects of tiling and slating that have been most frequently observed in BRE site investigations of roofing schemes, which could lead to deficiencies in the performance of the completed roof. The objective is to provide practitioners with a summary of the main good practice criteria.

Part 2 covers battening, nailing and product and material quality requirements for tiles.

Advice on weather resistance, underlays and thermal insulation for warm roofs is contained in Part 1. Slating using natural and manmade slates is described in Part 3.



Figure 1 Every tile in this roof should have been twice nailed

Design criteria

Weather resistance

Tiles may be either single- or double-lap. Plain single-lap units are normally larger than double-lap. Profiled tiles are normally single-lap, but with interlocking edge profiles. However, there are exceptions: pantiles, for example. Provided all units, whether large or small, interlocking or not, are laid to BS 5534 or to manufacturers' recommendations, there should be little difference in their weathertightness properties.

A number of materials from which tiles are made are porous, but this does not affect their rain exclusion function as the pores are relatively small, and water is not forced through the body of the tile by the wind or gravity.

Fine powdered snow may penetrate gaps in tiled roofs which may not leak water. Keeping out this snow will depend on the integrity and stiffness of the air seal provided by the underlay and the air pressures in the space between the underlay and the tiles.

About this Good Building Guide

This Good Building Guide covers:

- Clay and concrete interlocking tiles;
- Clay and concrete single-lap plain and double-lap plain tiles;
- Slates;
- Tilestones;
- In fact, everything above and between the bare rafters, including appropriate boarded and sheet sarkings, underlays, thermal insulation boarding in warm roofs, ventilation requirements between underlays and tiles or slates, battens, fixing and clipping, mortar bedding, verges, eaves and abutments, ventilated and fully bedded ridges.

This Good Building Guide does not cover:

- Peg-tiles (nowadays used only in restoration work);
- Bitumen felt shingles;
- Wood shingles;
- Metal tiles;
- Thatch.

For guidance on these topics and other aspects of roofs, see BRE's reference work *Roofs and roofing* (BR 302).

Tiling and slating pitched roofs: Natural and manmade slates

GBG 64 Part 3

Harry Harrison

This 3-part Good Building Guide deals with the upper surfaces of pitched tiled or slated roofing. It concentrates on those aspects of tiling and slating that have been most frequently observed in BRE site investigations of roofing schemes, which could lead to deficiencies in the performance of the completed roof. The objective is to provide practitioners with a summary of the main good practice criteria.

Part 3 covers battening, nailing and product and material quality requirements for slates.

Advice on weather resistance, underlays and thermal insulation for warm roofs is contained in Part 1. Tiling using plain and profiled clay and concrete tiles is described in Part 2.



Design criteria

Weather resistance

Slates are normally laid double-lap. Provided all slates, whether large or small, natural or manmade, are laid to BS 5534 or to manufacturers' recommendations, there should be little difference in their weathertightness properties.

Fine powdered snow may penetrate gaps in slated roofs which may not leak water. Keeping out this snow will depend on the integrity and stiffness of the air seal provided by the underlay.

Natural slate is relatively non-porous, and weathertightness depends primarily on adequate lap and gauge rather than material thickness. For manmade slates, weathertightness depends on product quality and fixing provision (Figure 1, page 2).

About this Good Building Guide

This Good Building Guide covers:

- Clay and concrete interlocking tiles;
- Clay and concrete single-lap plain and double-lap plain tiles;
- Slates;
- Tilestones;
- In fact, everything above and between the bare rafters, including appropriate boarded and sheet sarkings, underlays, thermal insulation boarding in warm roofs, ventilation requirements between underlays and tiles or slates, battens, fixing and clipping, mortar bedding, verges, eaves and abutments, ventilated and fully bedded ridges.

This Good Building Guide does not cover:

- Peg-tiles (nowadays used only in restoration work);
- Bitumen felt shingles;
- Wood shingles;
- Metal tiles;
- Thatch.

For guidance on these topics and other aspects of roofs, see BRE's reference work *Roofs and roofing* (BR 302).

Ventilated and unventilated cold pitched roofs

Charles Stirling

BRE Scotland

In a 'cold' pitched roof, the insulation is fitted at ceiling level. With this construction, there is a risk of condensation on the underside of the roof; the thicker the insulation layer, the greater is the risk of condensation and of damage to the materials. Since the late 1960s, the accepted solution has been

to introduce ventilation into the loft space by openings to the outside at eaves and ridge. More recently, vapour permeable underlays are sometimes used as an alternative to ventilation. With the introduction of the unventilated cold pitched roof, we need to clarify the general principles and

risks and identify approved construction techniques. By giving guidance on the technical risks associated with ventilated and unventilated forms of cold pitched roofs, this Good Building Guide responds to some of the confusion and conflicting views.

Pitched roof construction

The traditional pitched roof consists of a framework of structural elements, usually timber, including rafters and purlins which provide support to the sarking or underlay layer which may be boarded (typical practice in Scotland) or may simply be a waterproof membrane or underlay, eg bituminous felt. Over this sarking layer, tiling battens are nailed directly to the structural member (rafter) or to the sarking boarding to provide support and a fixing point for the weatherproof layer which is normally concrete or clay tiles, slates or some form of impermeable sheeting. Some roof constructions also incorporate counter-battens which assist in the drainage to the roof (Figure 1, page 2). Where natural slates are used these may be fixed directly to the sarking boarding but can also be fixed to battens.

Pitched roofs have historically been insulated at ceiling level, ie between the ceiling joists. This results in a cold loft or roof space, hence the term 'cold' pitched roof. With the insulation positioned horizontally below the inclined structural members and sarking there



Typical ceiling insulation in a cold pitched roof

is a risk of condensation forming on the underside of the sarking layer. In some cases, moisture arising from this condensation will result in staining or mould growth, and in extreme cases, physical deterioration of the roof elements.

As the majority of domestic roofs are constructed from timber and steel components which are susceptible to moisture, this condensation risk can be a problem. *Good Repair Guide 30* deals with the risk of

Ventilating thatched roofs

GBG 32

Thatch is naturally air and moisture permeable; when constructed traditionally it provides a weather resistant, breathable and highly durable roofing material. However, the introduction of modern impermeable plastics, the requirements of building regulations for additional

insulation and reduced air leakage, can increase the risk of condensation within the thatch, so affecting its durability.

This guide explains how to reduce that risk by introducing cavities and ventilation below the thatch. It applies to new roofs and where the thatch

of an existing roof is to be replaced completely. The local planning authority may require a consent application for the removal of thatch or if the insertion of new materials would change the behaviour of the roof.

The recommendations in this guide highlight specific requirements but it is recognised that thatch does not always conform to the regular format of modern slating and tiling materials. It may not always be possible, therefore, to adhere strictly to these recommendations or to incorporate specific detailing, for example ridge ventilation. However, we recommend that you assess fully the potential risks and where positive ventilation cannot be introduced, you create sufficient air space below the thatch to allow transfer of moist air.

The successful thatched roof relies on the combination of a number of factors, including the selection of the correct materials of high quality, good workmanship and sound detailing. Designers and specifiers should use accredited thatch specialists because much of the thatcher's craft is beyond the brief of modern construction technologists.



Structural design and performance

Structural design and performance

Applying flood resilience technologies

GG 84

Connecting walls and floors: Part 1. A practical guide

GG 29-1

Connecting walls and floors: Part 2. Design and performance

GG 29-2

SAMPLE

Good Building Guide

Applying flood resilience technologies

Stephen Garvin and Katy Hunter

This Good Building Guide outlines steps that can be taken to protect buildings or communities against flooding by means of flood resilience (FRe) technologies, that is, flood protection products which can provide resistance or resilience to flooding impacts.

It covers two particular types of FRe technologies, aperture barriers (or property level protection) and perimeter barriers, and provides information on:

- types of flooding
- flood risk management strategies
- flood survey
- types of FRe technologies
- design and testing standards
- installation procedures
- maintenance requirements.

This practical guidance will help developers, planners, designers, construction managers and operatives to identify flood risk, plan for flood risk management, and correctly design, install and maintain FRe technologies.

Introduction

Recent flooding events worldwide have shown that existing flood defence structures do not guarantee a sufficient level of protection for people and properties. Climate change and rapid urbanisation mean that the situation is likely to become more severe. In this unfavourably changing environment, a shift from the traditional approach is required to cope adequately with future flooding events. This Good Building Guide outlines steps that can be taken to protect buildings and communities against flooding using flood resilience (FRe) technologies, that is flood protection products which can provide resistance or resilience to flooding impacts.

The Good Building Guide covers the key points to be considered when selecting FRe technologies as part of a flood risk management strategy. It describes two types of FRe technology



Figure 1: One of many flooded streets after the River Thames burst its banks near Windsor in February 2014 (image courtesy of www.shutterstock.com)

which can help to protect a building or series of buildings against flooding:

- perimeter barriers to prevent water reaching a building
- aperture barriers to prevent water getting inside.

Figure 2 shows the process that should be followed when planning to reduce flood risk for a building, or series of buildings. The steps are to:

- identify flood risk
- plan for flood risk management
- correctly design, install and maintain FRe technologies.

A similar process was adopted in guidance, *Six steps to flood resilience*^[1], produced by BRE and the University of Manchester as part of the SMARTeST project*. Two versions of the guidance

* The SMARTeST Project was an EU FP7 funded research project focusing on smart and innovative flood resilience technologies, systems and tools. For more information, visit: <http://floodresilience.eu>.

Connecting walls and floors

GBG 29

Part 1

A practical guide

The current Building Regulations require floors and roofs to be tied or strapped to the walls to maximise the stability and robustness of the structures. While this occurs naturally in frame structures, it must be

considered at the design stage for masonry structures. New structures can be built with this requirement in mind, but many older buildings, mainly domestic, do not meet it. This first part of the Guide examines a number

of retro-fit fixing systems that can bring structures up to modern safety standards, alleviate bulging in walls and other related stability problems. Part 2 considers design and performance issues of wall and floor ties.

Many buildings in the UK show evidence of insufficient tying; some have no ties at all. The walls of these buildings can eventually bulge and become unstable. Walls at roof level may also become susceptible to wind damage.

When most of these houses were built, it was common practice to span the floor between a front or rear wall and a loadbearing spine wall. Since there was no dead-load restraint on the flank walls (except, perhaps, trimmer joists

either side of the stairwell), some bulging eventually occurred. This problem also affected larger institutional structures and blocks of flats.

Many older structures relied purely on a frictional connection to connect the floor with the wall. If the bearing was insufficient, however, or the load on the floor was small, the wall was still likely to move outwards eventually.



Figure 1 Traditional cottage with remedial through-tied gable walls

Connecting walls and floors

GBG 29

Part 2

Design and performance

The current Building Regulations require floors and roofs to be tied or strapped to the walls to maximise the stability and robustness of the structures. While this occurs naturally in frame structures, it must be

considered at the design stage for masonry structures. New structures can be built with this requirement in mind, but many older buildings, mainly domestic, do not meet it. Part 1 of this Guide examines a number of

retro-fit fixing systems that can bring structures up to modern safety standards, alleviate bulging in walls and other related stability problems. This second part considers design and performance issues of wall and floor ties.

The current requirements for wall-floor ties in the Building Regulations and Codes of practice are prescriptive; no calculated design guidance is given. The installation of ties is referred to only in the general requirements for stability and robustness rather than in any specific design context.

The main reason for installing wall-to-floor ties is to transfer to floors any out-of-plane loads on walls arising from:

- eccentricity of the loads on walls;
- out-of-plumb or other faults;
- wind pressure or suction;
- storage of heaped materials against walls (this practice is not recommended);
- accidents such as explosions or vehicle impacts.

Rules on strapping and tying to achieve stability and robustness apply only to buildings up to four storeys high. Buildings of five storeys or more are subject to the more stringent requirements of Clause 20.3 and Section 5 of BS 5628 Part 1.



Figure 1 Restraint ties supporting the front wall of a terraced house

Building design

Building design

Bats and refurbishment
Building without cold spots

GR 36
GG 35

SAMPLE

BATS AND REFURBISHMENT

Jan Collins, RSK Carter Ecological

This Good Repair Guide focuses on bats because they are so commonly encountered in existing buildings. The drive for sustainability and building refurbishment has increased the likelihood that bats could be disturbed, injured or killed, or that bat roosts could be destroyed. The construction industry must therefore be proactive in minimising impacts on these animals and providing enhancements where possible. Although not covered here, other protected species such as nesting birds, reptiles, barn owls, badgers, great crested newts, dormice, otters and water voles may also require consideration.

INTRODUCTION

Most people working in construction have heard stories of projects running into problems with legally protected animals, especially bats. However, if professional ecological advice is sought early on in any project, bats can become an asset and are unlikely to cause serious delays or excessive costs.

Bats are an important part of our natural environment. They make up over a quarter of our UK mammal species, play a key role in controlling insect populations and are indicators of a healthy environment, which relates to the quality of human life.

LEGAL PROTECTION AND LICENCES

There are 17 UK bat species, many of which rely heavily on the built environment for roosting sites. Anywhere that a bat rests during the day (and sometimes even the night) is classed as a roost.

All bat species are protected by UK and European law: it is illegal to kill, injure or disturb a bat, or to damage, destroy or obstruct access to a roost. This applies even if the animals are absent at the time, as bats move around between different roosts and will often



Figure 1: Two Daubenton's bats roosting in a cellar

return to favoured roosts at particular times of year.

Works as seemingly minor as timber treatment or replacing slipped tiles could harm bats or roosts; this could have serious implications including fines of up to £5000 per disturbed/harmed bat, six months in jail and extremely negative publicity. For those companies with an environmental management system such as ISO 14001 or EMAS (Eco-Management and Audit Scheme), continual compliance with environmental legislation is essential for accreditation and re-accreditation. Non-compliance could lead to the loss of accreditation.

The first approach to activities that could impact on bats should be a consideration of how those impacts could be avoided; for example, can the bats be left undisturbed and existing bat roosts and bat entrance points be retained?

Where all possible alternatives have been considered and rejected, development licences can be granted to allow for activities that would otherwise be illegal, such as disturbance of bats and destruction of roosts. Development licence applications should include data about bat populations (species, numbers, roost status), the

Earth, clay and chalk walls: inspection and repair methods

GRG 35

Peter Trotman

BRE Centre for Construction Consultancy

Around the UK, a variety of earth-walling construction methods and practices have been developed over many centuries depending on the characteristics of the subsoils and on local traditions. Since the 1980s there has been a resurgence of interest in the techniques used mainly to ensure appropriate repairs for maintenance and extension of existing buildings. However, there is also a growing interest in earth-walling construction methods and practices for new build as a means of reducing the environmental impact of building and of employing more sustainable and natural building methods. This Good Repair Guide focuses on inspection of existing earth, clay and chalk walls and the use of traditional repair methods to rectify defects.



Figure 1 Rebuilt and extended cob barn in Devon
(Courtesy of Kevin McCabe)

Earth or chalk was widely used for construction of dwellings and farm buildings in many areas of the British Isles, both in loadbearing form as mass walls and as infill for timber-frame walls (Figure 2). There are distinctive techniques for construction dependent both on the characteristics of the locally available subsoils and on local traditions.

The techniques of earth walling have been revived in the 1980s and 1990s, mainly to ensure authentic repairs and maintenance of existing buildings. A few extensions and small buildings have been erected and there is much interest in the wider use of the methods for new build. As environmentally friendly systems they have great advantages:

- the materials are cheap and easily acquired:
 - the existence of many farm ponds show the sites of material extraction,
 - straw or other vegetable fibre is freely available,
- embodied energy requirements are low if mainly animal and manpower are used.

Earth-walling techniques

A variety of construction methods and practices are found throughout the UK. Materials used are subsoil, usually with a proportion of clay, and chalk. For a regional account of local traditions see Hurd & Gourley (2000).

Cob, cleam, clob or clom, whitchert, clay dabbins and mud wall

These walls are built of subsoil with a high clay content, mixed with straw and water (Figure 3), placed in situ on a stone plinth about 600 mm wide, heavily trodden down, and then pared back to an even line. Large numbers were built in the West Country up to about the end of the 19th century (in excess of 50 000 in Devon alone; Figures 1 and 4); some survive from the 1400s.

Particularly good subsoil is found between Oxford and Aylesbury and is known locally as 'whitchert', meaning 'white earth'. Chalk cob is common in Hampshire, as far north as Andover, and Dorset. Where chalk is the main constituent,

Housing design and rehabilitation

Housing design and rehabilitation

Habitability guidelines for existing housing	GG 9
Outline guide to assessment of traditional housing for rehabilitation	GG 6
Supplementary guidance for assessment of timber-framed houses: Part 1. Examination	GG 11
Supplementary guidance for assessment of timber-framed houses: Part 2. Interpretation	GG 12

SAMPLE

Habitability guidelines for existing housing

One issue which is often not considered fully during the planning of housing rehabilitation projects is the *habitability* of the building - *the level of comfort, convenience and efficiency of operation** which will be provided when the proposed work is complete.

For surveyors and planners this guide provides a checklist to help identify any shortcomings related to habitability in existing dwellings. To assist in a more thorough assessment of a property the more common deficiencies are highlighted in more detail with requirements and recommendations for the rehabilitated building.

Future Good Building Guides will offer practical advice on how the identified habitability levels can be achieved.



Will the stair be sufficiently well lit and safe ?

Background

Detailed legislation in the Local Government and Housing Act (the DOE Fitness Standard, Page 6) sets out *minimum* requirements for occupation of dwellings, including the provision of basic amenities. Grant aid is available to help owners to bring existing dwellings up to these minimum requirements and therefore to ensure that they are *fit for habitation*.

Building work undertaken to meet the requirements of the Act will often need to satisfy the Building Regulations. You will need to refer to the appropriate Approved Document (Page 6) if planned work embraces any of the following categories as defined in the Building Regulations:

- Extension,
- Material alteration or change of use,
- Addition of sanitary, drainage or heating (using a burnable fuel).

Surveys carried out by BRE have shown that in terms of habitability, many rehabilitated buildings fall short of reasonable expectations. Aspects of construction which influence the comfort, ease of use and safety of a building were commonly found to be inadequate.

This guide identifies those parts of a dwelling which most often require careful attention during rehabilitation. In some cases (eg heating, ventilation and lighting) the guidance summarises the *statutory requirements* in the DOE Fitness Standard and any necessary work will usually be eligible for grant aid. Some aspects of habitability, such as sound insulation and layout, fall outside the currently accepted scope of the Fitness Standard; these are included here as *voluntary recommendations*; they merit consideration where habitability has a high priority and where the necessary independent funds are available.

Changes of use often have major implications. Any change from single to multi-occupancy of a building will need particularly careful assessment if habitability is a primary consideration. For example the provision of adequate sound proofing between dwellings, provision of effective damp proofing in basements or modification to meet the needs of particular categories of occupant may prove excessively expensive and on careful evaluation may therefore not prove worthwhile.

* The term 'habitability' and its definition as used here is distinct from the concept of 'fitness for habitation' which is concerned with the specification of minimal requirements.

Outline guide to assessment of traditional housing for rehabilitation

Rehabilitation work presents particular problems and a need for specialist skills among all professions involved. In practice the problems are often underestimated and final costs frequently rise unacceptably beyond original estimates. In addition because of a shortage of practical advice and formal training to encourage development of appropriate skills there is a risk that building deficiencies may not be identified or corrected during rehabilitation. Findings from a recent survey* indicate that although typical rehabilitation projects do achieve improvements in layout and amenity, they may be less successful in resolving more fundamental problems, some with serious implications for the long-term performance of the building.

This guide outlines recent BRE guidance (see Further information, page 4) on property assessment prior to commencement of rehabilitation works. The assessment process is uniquely important in rehabilitation because it enables a realistic evaluation of the work required, including any complications, and an objective framework for costing.



Careful assessment of this attractive property may reveal sound, cost effective rehabilitation options and eliminate those which are costly or inappropriate.

The importance of property assessment

A reliable assessment of a property for rehabilitation will normally need to involve three steps:

- A standard dimension survey
- A condition survey
- A desk assessment

The assessment stage in particular is complex. It requires an awareness of which aspects of performance are important for each building

element or service (page 2) and insight, in the absence of nationally accepted standards, into the levels of performance which would be acceptable. In addition, assessment requires knowledge of the specific and sometimes complex building processes involved in rehabilitation (page 3). It also requires an appreciation of the implications of changes (page 4), whether major (such as alterations in layout) or minor (for example when upgrading the performance of a particular element or component).

* Rehabilitation - a review of quality in traditional housing. BRE Report 1990.

Supplementary guidance for assessment of timber-framed houses: Part 1 Examination

This two-part guide supplements existing inspection procedures for timber-framed houses. It is intended for use by building surveyors where a detailed survey, carried out in accordance with guidelines published by TRADA (1) or TBIC (2), has indicated a need for further investigation. Part 1 includes guidance on visual

re-examination of the building exterior and interior and then considers how to examine the wall cavity and frame if a deficiency related to structural stability, durability or fire protection is suspected. Guidance on the interpretation of information collected is given in Part 2 (Good Building Guide 12).

When to use this guide

The TRADA or TBIC survey procedure (1, 2) will have established that the house is of timber framed construction and not of any other type, such as cross wall construction, which might include timber members.

GBG 11 and 12 (3) is a two-part guide intended for use in cases (see below) where survey results are inconclusive or have identified a problem related to structural stability, durability or fire protection. It is intended for use with single-occupancy properties of up to three storeys and is relevant to most types of timber frame wall construction. Surveyors should be aware that as well as the more common wall type (shown right) other designs may be encountered; those with sheathing or insulation in different positions may not be so easy to examine from the inside of the building.

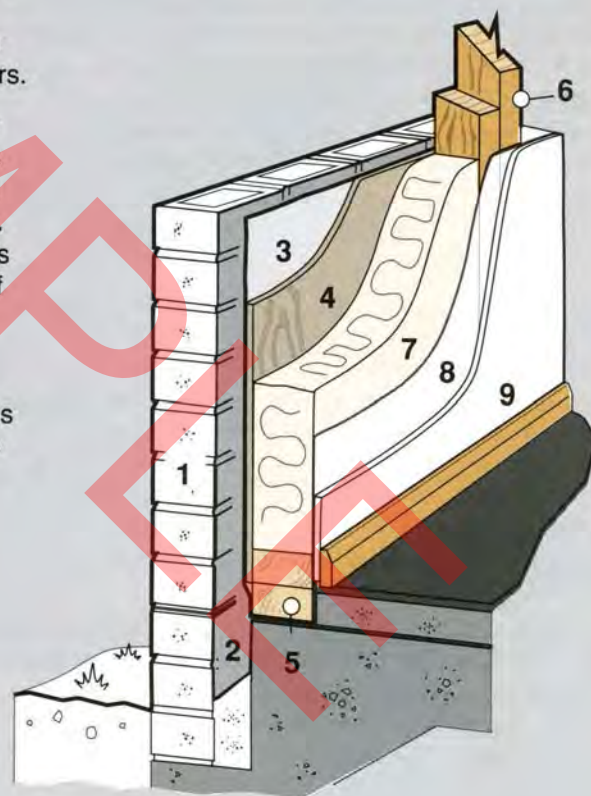
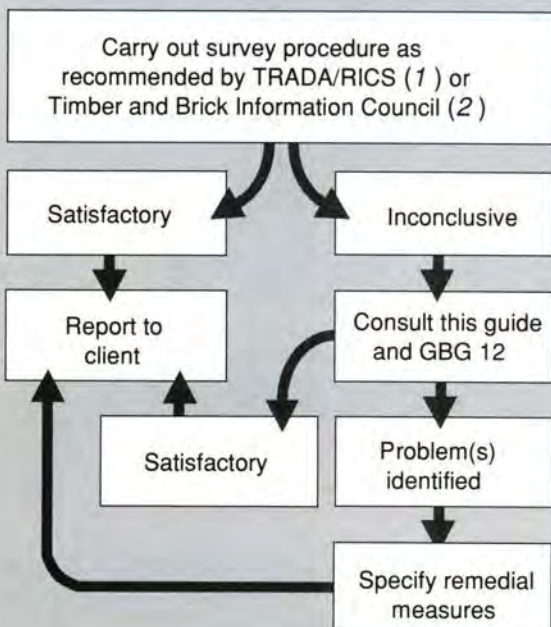

Typical timber frame wall design

- | | |
|---------------------|------------------------|
| 1 Cladding | 6 Frame member |
| 2 Cavity | 7 Insulation |
| 3 Breather membrane | 8 Vapour control layer |
| 4 Sheathing | 9 Interior lining |
| 5 Sole plate | |

Supplementary guidance for assessment of timber-framed houses: Part 2 Interpretation

With timber-framed houses, as with any other type of construction, site findings and observations require careful interpretation during the preparation of a condition report. This Guide shows **how** to assess the significance of **key observations** and readings which may have been taken during an **earlier survey or supplementary inspection** (see Part 1 of this Guide, GBG 11).

Based on BRE **research and feedback** to the BRE Advisory Service, this guide includes new advice for assessing building condition, and identifying any need for remedial work. Although intended for use with conventional timber frame design, the guidance has general applicability to less common timber frame systems.



Timber-framed houses with brick cladding

Use of this guide

During the development of a final inspection report, surveyors and other professionals involved in assessing timber-framed housing may need to provide interpretation of the site findings at three levels:

- 1 To establish if there is any change or deterioration which might have affected the building **structure** (pages 1 to 3) or its **durability** (pages 4 and 5). This guide focuses mainly at this level and will be supported by further guidance on appropriate repair or refurbishment work which may be necessary.
- 2 To establish any serious shortcomings which may impair the performance of the building to a level below that considered to be adequate (see page 6).
- 3 To establish if the building met the standards required at the time of construction. This level is beyond the scope of this guide.

Assessing structural information

The timber frame provides the support for the house. Its rigidity and strength relies mainly on nailed joints between component parts, and the box effect created by the composite action of walls, floors and roof. If reasonably well constructed, the box structure is stable and, provided there is no loss in the integrity of the wood in the frame, the structure will remain sound even if some individual joints do become weakened or fail.

Although some instances of structural distress have been observed, related to faults during construction, none have led to structural failure and it appears that safety factors included in design have been adequate. This suggests that surveyors can assume that the structure is sound without the need to examine internal joints, unless there are obvious signs of structural distress and/or deterioration of components. The chart on pages 2 and 3 gives a list of signs of distress which may merit remedial action. Some remedial works will be very expensive and the need for these should be balanced against the age of the property and its intended future service life.

Site organisation and management

Site organisation and management

Construction and demolition waste	GG 57
Construction site communication: Part 1. General	GG 54-1
Construction site communication: Part 2. Masonry	GG 54-2
Offsite construction: an introduction	GG 56
The Quality Mark Scheme	GG 55
Working with local businesses and residents	GG 71

BRE Centre for Resource Management

- I How much waste?
- I Options for waste management

Waste costs and someone has to pay. With the increasing cost of raw materials and the rising cost of waste disposal due to ramping up of landfill tax, better management of waste makes sense. Industry and Government are exploring more effective ways of tackling waste with the aim of identifying best practicable environmental options (BPEO) for the reclamation and reuse of building components, as well as the recovery and recycling of materials.

The potential benefits of formulating a waste management policy include: savings in disposal and transport costs, revenue from reuse and recycling, reduced purchasing of materials and improved environmental credentials. Part 1 of this Good Building Guide puts construction and demolition waste into context and outlines the options for better management.



The waste of building components is increasingly unacceptable to the construction and demolition industries. The array of current and proposed legislative, fiscal and policy frameworks affecting the construction and demolition industries, plus the likelihood that these will become more stringent, has heightened the urgency for action on this issue. Industry and Government are looking for proactive ways of effectively tackling waste. The aim is to identify practicable options for the reclamation and reuse of building components, as well as the recovery and recycling of materials.

The Environmental Protection Act 1990 and subsequent related legislation has led to changes in the responsibilities and legal requirements affecting producers and handlers of waste. This includes the Duty of Care, Registration of Carriers and exemption of many recycling activities from waste management licensing.

How much waste?

Much of the UK's construction waste, estimated at 15 to 20 million tonnes each year, currently goes to landfill sites. Together with demolition and excavation wastes, the overall UK figure for construction and demolition (C & D) waste is believed to be between 90 and 120 million tonnes (based on limited figures often quoting each other). Much of this waste is avoidable and reduces the already small profits of construction companies. Some estimates indicate that this waste is a large proportion of those profits, typically 25%. A 20% reduction in waste could divert 6 million tonnes of material from landfill, saving approximately £60 million in premium rate disposal costs.

As much as 96% of the UK construction industry is made up of small and medium enterprises (SMEs). Of 190 000 registered construction companies, only a small proportion practise any kind of segregation of waste on site or have a true picture of the real costs of wastage to

BRE Centre for Resource Management

I Dealing with waste

Waste costs and someone has to pay. With the increasing cost of raw materials and the rising cost of waste disposal due to ramping up of landfill tax, better management of waste makes sense. Industry and Government are exploring more effective ways of tackling waste with the aim of identifying best practicable environmental options (BPEO) for the reclamation and reuse of building components, as well as the recovery and recycling of materials.

The potential benefits of formulating a waste management policy include: savings in disposal and transport costs, revenue from reuse and recycling, reduced purchasing of materials and improved environmental credentials. Part 2 of this Good Building Guide gives advice on how to deal with waste during the demolition and construction processes.



Dealing with demolition waste

Demolition, particularly with explosives or crushing plant, has only one usable outlet, that of recycling. *Deconstruction* aims to reclaim components without damage and through a prescribed process. However, there are barriers to deconstruction and costs in reclaiming structural and non-structural components for reuse. Planning ahead is essential to maximise reuse.

Planning ahead

Before letting a demolition or construction contract, establish the opportunities for reuse and recycling:

- I ensure fittings, fixtures and furniture are reused wherever possible,
- I arrange for a pre-demolition audit, reclamation valuation and environmental quantification of the building by BRE,
- I discuss your findings with potential contractors to establish costs and any plans they have for reuse or recycling. (*Note:* this may take longer

than a 'clear the site' option but revenue from salvaging will reduce the cost of demolition.)

Fixtures and fittings

The building can be soft stripped of reusable items such as furniture, timber offcuts, light fittings, venetian blinds, fire alarm equipment, heaters, dryers, light switches and sockets. Items can be donated to charities if of no use to the client. There is a demand for switchgear and boiler equipment in developing countries but companies dealing in this area may need a few weeks notice in which to dismantle the equipment.

Reclamation audit

3.3 million tonnes of architectural and ornamental components are salvaged each year. An independent reclamation audit can be undertaken by BRE before demolition. The audit will provide information on what items and materials can be reclaimed from the building, given the current reclamation market. The findings should be discussed with the main contractor and the

Construction site communication

GBG 54

Part 1: General

Alastair Stupart, BSc MPhil

BRE Scotland

Every year defects in the UK construction industry cost at least £1 billion to repair or rebuild. Some of the defects will be the result of poor communication, for example, a poorly detailed drawing, operatives being given incorrect instructions

or technical information not being available. This Good Building Guide gives advice on how communication can be improved to and around a construction site. It is relevant to all trades and work activities on the site. Improvements in

communication should result in cost savings and a reduction in defects. The diverse nature of construction projects means that not all the recommendations will be applicable to all projects and all sites.

Other parts to this Guide

For advice on communication in the masonry team – see Part 2



BRE

Photograph courtesy of Marshalls

constructing the future

dti

Department of Trade and Industry

Construction site communication

GBG 54

Part 2: Masonry

Alastair Stupart, BSc MPhil

BRE Scotland

Every year defects in the UK construction industry cost at least £1 billion to repair or rebuild. Some of the defects will be the result of poor communication, for example, a poorly detailed drawing, operatives being given incorrect instructions

or technical information not being available. This Good Building Guide gives advice on how communication can be improved to and around a construction site with particular reference to masonry construction. Improvements in

communication should result in cost savings and a reduction in defects. The diverse nature of construction projects means that not all the recommendations will be applicable to all projects and sites where masonry is being built.

Other parts to this Guide

For general advice on site communication – see Part 1



Methodology of communication

Figure 1 illustrates a simple methodology for communication during the different phases of a brickwork or blockwork project. The reader should refer to Figure 1 when reading each section in this *Good Building Guide*.

Phase 1: Design

Masonry project communication (1A)

At the outset and/or the contract stage, the ways in which project communication will be designed to work should be agreed. Issues that need to be agreed include those in Box 1.

Drawing provision and distribution (1A, 2)

The role of drawings in producing good quality masonry is crucial. Therefore, careful attention must be paid to how drawings are going to be produced, checked and distributed. Box 2 gives a checklist. *The provision of complete and correct drawings should be regarded as being as important as ensuring that materials and operatives are available.*

Photograph courtesy of Marshalls

Off-site construction: an introduction

GBG 56

Charles Stirling

BRE Scotland

Building all, or some components, of buildings off site in a factory has been a feature of construction over many generations, and in some cases has been adopted extensively (eg door and window sets). Many terms have been used to describe this off-site construction (prefabrication, off-site assembly, factory assembly, pre-assembly, off-site manufacture, etc.). In this Guide the term 'off-site construction' will be used to refer to any part of the construction process that is carried out in controlled conditions away from the actual site where the building is or will be sited. In the post-war period, prefabricated construction unfortunately acquired negative connotations. However, with developments in lightweight, high strength materials and modern production techniques, prefabrication has much to offer today's construction industry. This Good Building Guide provides an introduction to the techniques and methods of off-site construction and suggests how these might be adopted within the modern construction process.



Photograph courtesy of Kingspan

Off-site construction is often perceived as highly specialised and to many designers and specifiers is only applicable to a limited number of construction projects. There are, however, many examples of off-site construction being incorporated within the mainstream construction process [eg stairs, doors and window sets, composite cladding panels, prefabricated foundation systems (Figure 1) and insulated walling panels (Figure 2)] and building services (air-conditioning or refrigeration packs).

When properly integrated early in the design process, off-site assembled components, assemblies and service runs can have a major impact on the construction process and can lead to improved performance by way of reduced times on site and improved quality. Prefabricated assemblies may initially cost more but reduced on-site assembly times and increased control over site processes should reduce risks and in many cases the overall project costs should be no more than those of conventionally constructed projects. Where there is a repeat aspect to the project or

where a large volume of prefabricated components are being used then the individual production costs and overall project cost can be reduced.

To realise the full benefits of off-site construction, the project team needs to address the specification and construction implications as early as possible in the design process. The integration of prefabricated components should become an inherent part of the overall design, rather than simply offering an alternative to an already determined design solution. As shown in Figure 3, disproportionate costs and subsequent waste can arise during the construction project or during the life of a building from a failure to fully understand the implications of the design.

Figure 3 highlights the potential for cost reduction and alternatively the resistance to the cost of change during the project life. As the project progresses, the opportunities for implementing variation or change reduce and the consequent costs associated with these variations rise substantially. Typically, around 80% of the construction costs are fixed within the first 20% of



The Quality Mark scheme has been introduced to give reputable tradesmen the opportunity to demonstrate their professionalism and clearly distinguish themselves from the cowboys. It has been developed by representatives from the construction industry, consumer bodies, and local and central government to make it workable yet rigorous for contractors, and accessible and effective for consumers.

Quality Mark is an independent scheme offering consumers peace of mind by giving them a reliable tool to select reputable tradesmen. It is backed by an independent complaints mechanism and a comprehensive warranty.



The Office of Fair Trading gets more than 106 000 complaints a year about cowboy builders, and this is probably only the tip of the iceberg. It is estimated that about £4bn worth of domestic work is not done on people's homes because the owners are afraid that workmanship will be poor or they'll be ripped off, or both.

The Quality Mark (QM) scheme has been set up by central government to protect consumers from the cowboys and is gradually being rolled out across England and Wales following pilot schemes in Birmingham and Somerset. A telephone survey in January 2003 to a sample of 500 UK homeowners produced these results:

- | 86% would prefer to use a QM-approved tradesman,
- | 76% would be more likely to give work to a QM-approved tradesman,
- | 39% would not contact a tradesman who is not QM-approved,
- | 54% would be prepared to pay more for work carried out by a QM-approved tradesman.

QM has been designed to suit the needs of all companies from the one-man band to a company with a turnover of £ millions, and to keep paperwork to a minimum. Most reputable companies meet the technical and skills requirements of QM without any problems. If necessary, help is available to meet QM requirements from the Construction Industry Training Board (CITB), trade associations, Business Link and others.

Consumers can contact the scheme's hotline (Tel 0845 300 80 40) or look up the website www.qualitymark.org.uk for details of independently inspected and approved tradesmen (builders, roofers, electricians, plumbers) in their area so that they can have peace of mind that a job will be done properly and at a fair price. In addition, all building work under the scheme is guaranteed for up to six years against loss of deposit, poor workmanship and major defects. The scheme includes Code of Practice documents (eg Policy statements and templates for estimates and contracts) and a complaints resolution system.

Working with local businesses and residents

GBG 71

Mindy Hadi

BRE Environment

A large construction project can have a variety of unwelcome impacts on the lives of local residents and businesses. Research has shown that the impacts of most concern are noise, dust, traffic and parking (see Box 3 for a fuller list of the major impacts). However, these impacts can be mitigated by planning, communication and consideration from construction companies. The business benefits to the client from working with local businesses and residents are substantial.

This Good Building Guide sets out a communications strategy to keep the local community informed, outlines how to deal with complaints and lists a range of good practice measures that can be implemented to reduce the major impacts (eg noise- and dust-reducing measures and traffic management schemes).



The construction industry and its clients are becoming increasingly aware of the importance of giving more consideration to the needs of the local community during construction work. As well as reinforcing the social dimension of sustainable construction by demonstrating a commitment to corporate social responsibility, improved relationships with the local community can bring substantial business benefits both in the short and long term. Some examples are given in Box 1.

Research has highlighted concerns among local communities and has indicated that residents and businesses are most worried about: noise, dust, traffic and parking. By and large, the local community appreciates that a major construction project in their neighbourhood will inevitably cause a certain amount of disruption and disturbance. However, they will usually put up with the majority of these problems if there is communication and consideration throughout the process from construction companies, clients, local councils and developers.

Box 1 Benefits from working with local businesses and residents

- Time and cost savings resulting from a smoother planning process.
- Increased goodwill towards a construction project both during and post construction.
- Reduction in the time and money spent dealing with complaints.
- A greater sense of ownership of the project among local people leading to reduced vandalism and improved security.
- Enhanced PR for the client and contractor.
- Increased potential for repeat construction business in the locality.
- Improved job satisfaction and motivation among the workforce on site.

A major factor in working successfully with the community is the importance of planning. Any potential impacts on local people and businesses should be considered from the earliest stages and throughout the life of the construction project. Many of the good practice measures suggested in this *Good Building Guide*, for example, traffic

Acoustics and sound insulation

Acoustics and sound insulation

Improving sound insulation Part 1	GR 22-1
Improving sound insulation Part 2	GR 22-2
Minimising noise from domestic fan systems: Fan-assisted radon mitigation systems	GG 26
Sound insulation in dwellings: Part 1: An introduction REVISED 2014	GG 83-1
Sound insulation in dwellings: Part 2: New-build REVISED 2014	GG 83-2
Sound insulation in dwellings: Part 3: Material change of use (conversions) REVISED 2014	GG 83-3

Improving sound insulation

Good Repair Guide 22

Part 1

BRE inspections of rehabilitation work in progress have revealed instances of inadequate separating walls between dwellings, including half brick or brick on edge, large gaps or absence of walls in roof spaces, and

holes alongside floor joists or other timbers built into the walls. The principle of sound insulation is to ensure that the resistance of separating walls is satisfactory by blocking all holes or by constructing an independent leaf.

This Good Repair Guide gives guidance to builders, householders and landlords on diagnosing a sound insulation problem and deciding on remedial action. There is also advice on sound insulation for flat conversions.

Other parts to this Guide

For remedial treatment of floors, sound insulation for flat conversions and legal solutions to noisy neighbours – see Part 2 of this Guide

Many people are bothered by noise from their neighbours. The problem can occur in any type of attached house, flat or bungalow but it is most common in flats that have been converted from large houses. Householders may be bothered by their neighbour's noise for the following reasons:

- l The householder's neighbour behaves unreasonably.
- l The householder is more sensitive than others to noise.
- l The sound insulation between the householder's home and the neighbour's is inadequate.

While everybody sometimes hears some noise from their neighbours such as raised voices, laughter and occasional loud music, it should not be possible to hear normal conversation or the television from next door. If excessive noise is heard from the neighbour's property then there may be a remedial solution or a legal solution to the problem. This *Good Repair Guide* offers guidance on both these options.

Remedial solution

The box, below, gives a strategy for finding a remedial solution to noise from a neighbouring property.

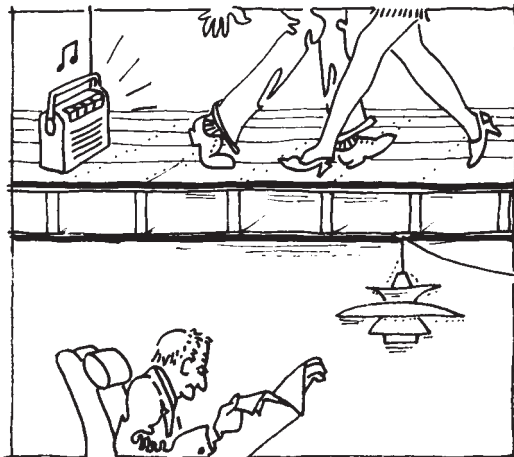

A common problem in converted dwellings

Steps to finding a remedial solution to noise from a neighbouring property

- Step 1** Confirm that the sound insulation is below average
- Step 2** Diagnose defective wall(s) or floor
- Step 3** Look for, and make good, any workmanship faults
- Step 4** Apply treatment

You could get professional advice (try the Association of Noise Consultants, telephone 01763 852958, or *Yellow Pages* under Acoustic Engineers) or you could do it yourself.

Improving sound insulation

Good Repair Guide 22

Part 2

BRE inspections of rehabilitation work in progress have revealed instances of inadequate separating walls between dwellings, including half brick or brick on edge, large gaps or absence of walls in roof spaces, and

holes alongside floor joists or other timbers built into the walls. The principle of sound insulation is to ensure that the resistance of separating walls is satisfactory by blocking all holes or by constructing an independent leaf.

This Good Repair Guide gives advice to builders, householders and landlords on diagnosing a sound insulation problem and deciding on remedial action. There is also advice on sound insulation for flat conversions.

Other parts to this Guide

For diagnosis of where sound is penetrating and remedial treatment of walls – see Part 1 of this Guide

Remedial solution

Step 4: Treatment

Floors

Impact sounds, mostly footsteps, travel mainly through the floor. The principle of increasing the sound insulation of floors is as described for walls in *Part 1*: sealing air paths, increasing mass or structural isolation by building a new lining below the existing ceiling. This is called an independent ceiling and it will be effective against both airborne sounds like speech and music and impact sounds like footsteps from the flat above. A resilient floor covering can further reduce impact sounds.

Building an independent ceiling

In refurbishment work remember that a 'converted' floor should have sound resistance comparable with that of separating floors in new construction.

- | Attach wall plates on opposite sides of the room to carry the joists. Choose the walls to give the shortest span. Ensure that the walls can carry the extra load by consulting a building surveyor or structural engineer. The additional ceiling should not be connected to the floor above.
- | Run joists between wall plates. They can be fixed by 'notching', see drawing, right.

Ensure the bottom of the joist is flush with the bottom of the wall plate.

- | Fix mineral wool quilt, or similar absorbent material, 25 mm or more thick, between the joists, or drape it over them.
- | Line the joists with two layers of plaster-board arranged so that joints between sheets in the first layer do not coincide with joints between the sheets in the second layer (see drawing, page 2, top). Fill gaps round the perimeter, eg by adding coving. The drawing, page 2, middle, shows the final construction.

All details should follow manufacturers' recommendations but the specification in Table 2 is given as a guide.

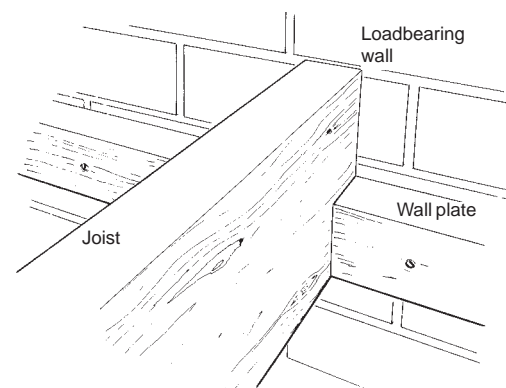

Method of notching a joist over a wall plate

Minimising noise from domestic fan systems and fan-assisted radon mitigation systems

Noise from domestic fan systems can be a problem. This Guide describes how to design a system to minimise noise disturbance. The Guide also includes advice on how to reduce noise from existing unsatisfactory systems.

The Guide will be of interest to householders, and to builders and designers dealing with noise from household fan systems used for ventilation, condensation control or radon reduction.

Most of this Guide applies equally to domestic fan systems and to fan-assisted radon mitigation systems.

Where it applies ONLY to radon systems, it is printed in blue.

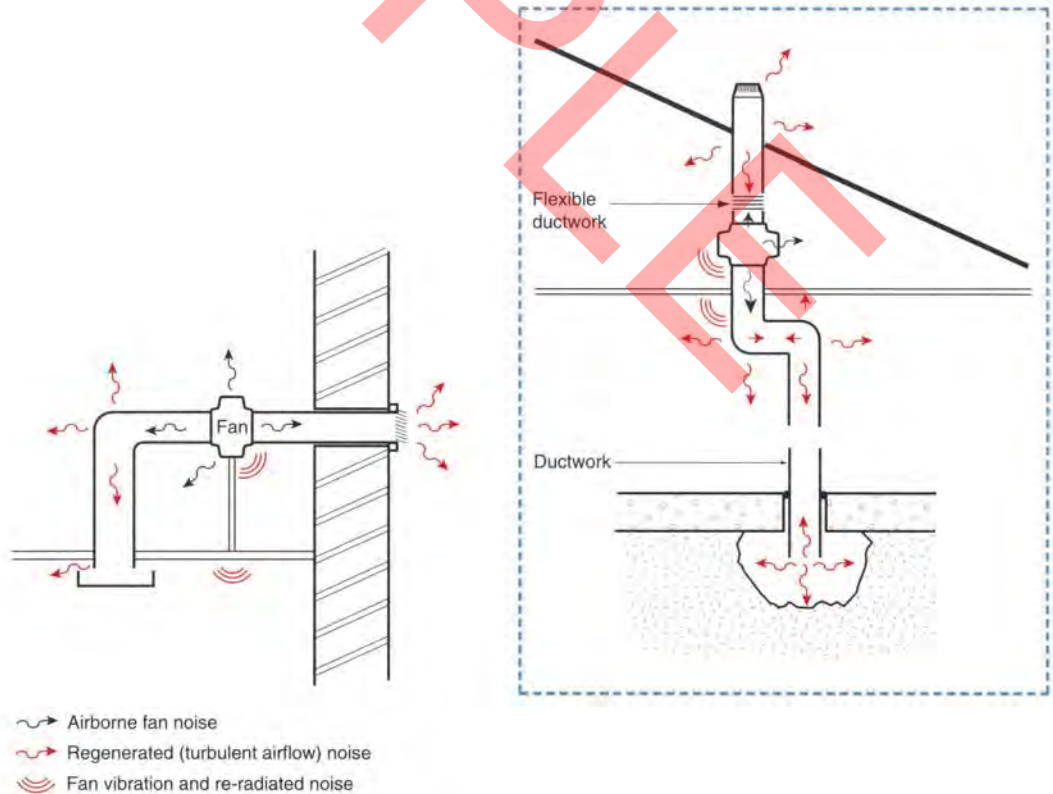

Figure 1 Main noise sources in (left) a fan system and (right) a radon extract system

Good Building Guide

Sound insulation in dwellings

Part 1: An introduction

Gary Timmins and Ian West

This Good Building Guide provides practical guidance for designers, construction managers and operatives, and property developers on understanding the requirements of national building regulations concerning the provision of sound insulation in dwellings. Part 1 explains the importance of providing good sound insulation between and within homes. It describes:

- the problems associated with neighbour noise
- how to satisfy the current regulatory requirements in England and Wales
- methods of measuring sound transmission in dwellings.

Considering the requirements relating to sound insulation at an early stage of any development reduces the likelihood of costly remediation measures and delays at completion.

Parts 2 and 3 give advice on providing the correct level of sound insulation when constructing new dwellings and converting a building into multiple dwellings.

The noise problem

Unwelcome noise in homes, specifically sound transmission between homes, is a major problem in the UK which requires serious consideration from both architects and builders. Noise nuisance can be a serious cause of stress and, if not remedied, can affect health and wellbeing as well as influencing people's enjoyment of buildings. People have different attitudes to noise; building occupants may be unaware that the noise they are making can be heard by their neighbours and regarded as a nuisance.

These problems can be solved by encouraging neighbours to modify their behaviour or by improving the level of sound insulation. As the noise climate within our homes mirrors



Figure 1: Terraced houses are required to control sound transmission between adjacent properties and within each property

changes in the way we live, more stringently applied national building regulations^[1-4] and enhanced specifications (eg the Code for Sustainable Homes (CSH)^[5]) have been introduced to control the transfer of neighbour noise.

Incorrect design of walls and floors, use of the wrong materials and poor workmanship can result in increased sound transmission, non-compliance with national building regulations and increased complaints from occupants. Failure to comply with the regulatory requirements leads to increased costs due to remediation works, delays to handover, continued involvement after practical completion and potential increases in future building warranty premiums.

Part 1 of this Good Building Guide, together with **Parts 2** and **3**, offers practical guidance on providing the correct level of sound insulation when constructing new dwellings or converting a building into multiple dwellings.

Good Building Guide

Sound insulation in dwellings

Part 2: New-build

Gary Timmins and Ian West

This three-part Good Building Guide provides practical guidance for designers, construction managers, construction operatives and property developers on understanding the requirements of national building regulations concerning the provision of sound insulation in dwellings.

Part 2 explains how to provide a reasonable level of sound insulation between new dwellings. New dwellings are subject to routine sample pre-completion testing to ensure that they comply with the minimum performance targets in the appropriate national building regulations and any site-specific requirements.

The regulatory requirements and more general information are provided in Part 1 of this publication^[1]. Part 3 will give advice on providing the correct level of sound insulation for converted dwellings.



Figure 1: Sound insulation must be considered throughout the building process for new homes

The noise problem

Unwelcome noise in homes, specifically sound transmission between homes, is a major problem in the UK that requires serious consideration from both architects and builders. Noise nuisance can be a serious cause of stress and, if not remedied, can affect our health and wellbeing as well as influencing our enjoyment of buildings. People have different attitudes to noise; building occupants may be unaware that the noise they are making can be heard by their neighbours and regarded as a nuisance.

These problems can be solved by encouraging neighbours to modify their behaviour and/or by improving the level of sound insulation. As the noise climate within our homes is affected by changes in the way we live, more stringently applied national building regulations^[2, 3, 4, 5] and enhanced specifications (such as The Code for Sustainable Homes^[6]) have been introduced to control the transfer of neighbour noise.

When considering sound insulation, it is the construction of the walls and floors that separate dwellings (separating walls and

separating floors) and their junctions with surrounding elements that is most important. Consideration of the sound insulation of internal partitions was discussed in GG 83-1^[1]. Incorrect design of walls and floors, use of the wrong materials and poor workmanship can result in poor sound transmission, non-compliance with building regulations and increased complaints from occupants. Failure to comply with the regulatory requirements leads to increased costs due to remediation works, delays to handover, continued involvement after practical completion and potential increases in future building warranty premiums.

This Good Building Guide considers the principal types of construction used in dwellings and divides construction into two types – heavyweight and lightweight:

- Heavyweight construction covers traditional materials and systems, including masonry or precast concrete walls, precast concrete floor units, and precast concrete beam and block floors.
- Lightweight construction typically uses framed construction of timber or metal.

Good Building Guide

Sound insulation in dwellings

Part 3: Material change of use (conversions)

Gary Timmins and Ian West

This three-part Good Building Guide provides practical guidance for designers, construction managers, construction operatives and property developers on understanding the requirements of national building regulations concerning the provision of sound insulation in dwellings.

The aim of Part 3 is to give practical advice and outline guidance on appropriate constructions that will provide a reasonable level of sound insulation between dwellings formed by a material change of use (conversions). Where new dwellings are formed in a building as a result of a material change of use, they are subject to routine pre-completion testing to ensure that they comply with the minimum performance targets in the appropriate national building regulations and any site-specific requirements.

The regulatory requirements and more general information are provided in Part 1 of this Good Building Guide^[1]. Part 2 explains how to provide a reasonable level of sound insulation between new dwellings^[2].

The noise problem

Unwelcome noise in homes, specifically sound transmission between homes, is a major problem in the UK which requires serious consideration from both architects and builders. Noise nuisance can be a serious cause of stress and, if not remedied, can affect our health and wellbeing as well as influencing our enjoyment of buildings. People have different attitudes to noise; they may not be aware that the noise they are making can be heard by their neighbour and is regarded as a nuisance.

These problems can be solved by encouraging neighbours to modify their behaviour or by improving the level of sound insulation. As the noise climate within our homes is affected by changes in the way we live, more stringently applied regulations have been introduced to control the transfer of neighbour noise:



Figure 1: Material change of use of a non-domestic building to a residential apartment block

- England Approved Document E (AD E), 2003 (amended 2004, 2010 and 2015)^[3]
- Wales Approved Document E (AD E), 2003 (amended 2004 and 2010)^[4]
- Scotland Technical Handbook, Section 5, 2013^[5]
- Northern Ireland Technical Booklet G, 2012^[6]

Enhanced specifications (such as BREEAM UK domestic refurbishment^[7]) have also been introduced.

When considering sound insulation, it is the construction of the walls and floors that separate dwellings (separating walls and separating floors) that is most important. Consideration of the sound insulation of internal partitions was discussed in Part 1 of this *Good Building Guide*^[1]. Incorrect design of walls and

Condensation and dampness

Condensation and dampness

Assessing moisture in building materials: Part 1. Sources of moisture	GR 33-1
Assessing moisture in building materials: Part 2. Measuring moisture content	GR 33-2
Assessing moisture in building materials: Part 3. Interpreting moisture data	GR 33-3
Building damp-free cavity walls REVISED 2015	GG 33
Diagnosing the causes of dampness REVISED 2015	GR 5
Remedying condensation in domestic pitched tiled floors	GR 30
Treating condensation in houses Treating rising damp in houses	GR 7
Treating dampness in basements	GR23
Treating rain penetration in houses	GR 8
Treating rising damp in houses	GR 6

Assessing moisture in building materials

Good Repair Guide 33

Part 1: Sources of moisture

Charles Stirling
BRE Scotland

Moisture can enter buildings for many reasons and the resultant damage to materials and components is well documented. There is much published guidance on the identification and possible remedies for

moisture defects. The objective of this *Good Repair Guide* is to provide building professionals with examples of analytical techniques which could be used to supplement visual information in the identification of moisture

problems. The number of techniques is large so only a limited number can be reviewed. Part 1 summarises the sources of moisture in building fabric and gives advice on analysing the possible causes.

Other parts to this Guide

For Measuring moisture content – see Part 2
For Interpreting moisture data – see Part 3

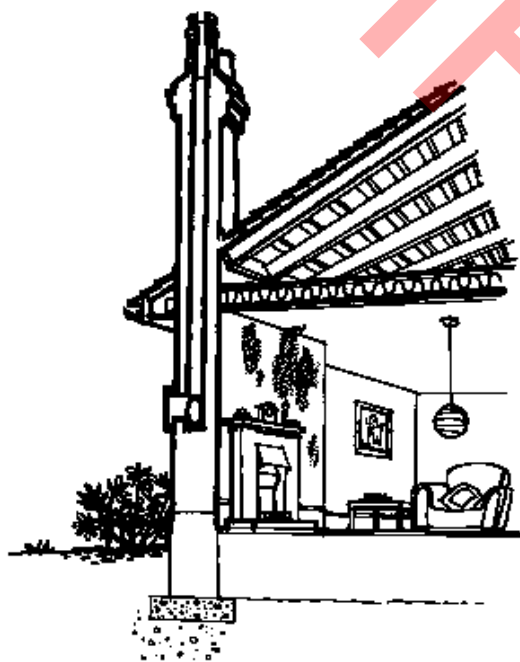

Is condensation, rain penetration or the effect of hygroscopic salts responsible for the damp seen on this chimney breast?

The diagnosis of the cause(s) of moisture in buildings is generally based on a visual examination of the resultant damage and the individual experience of the professional in assessing similar defects. Measuring apparatus and analytical techniques are available for determining the levels of moisture in a range of building materials. These techniques

- | can be expensive to install,
- | can take some time to produce consistent results,
- | can be difficult subsequently to interpret,
- | are generally only used in laboratories or test houses where samples and testing conditions can be well controlled.

Guidance is available on the use and interpretation of these techniques, however, much of it is not usually targeted at the building professional, ie building surveyors, engineers or architects. In addition, it does not generally give advice on how to interpret moisture data. This 3-part *Good Repair Guide* discusses some of the available analytical techniques, and in *Part 3* explains how to interpret the data collected from the application of these techniques.

Assessing moisture in building materials

Good Repair Guide 33

Part 2: Measuring moisture content

Charles Stirling
BRE Scotland

Moisture can enter buildings for many reasons and the resultant damage to materials and components is well documented. There is much published guidance on the identification and possible remedies for

moisture defects. The objective of this *Good Repair Guide* is to provide building professionals with examples of analytical techniques which could be used to supplement visual information in the identification of moisture

problems. The number of techniques is large so only a limited number can be reviewed. Part 2 discusses a range of techniques available for measuring moisture content in building materials.

Other parts to this Guide

For Sources of moisture – see Part 1

For Interpreting moisture data – see Part 3

Having identified that there is a moisture problem, and having gone some way to analysing the problem by visual examination and inspection, it may be necessary to gather measured data relating to the moisture content of affected materials and the environmental conditions relating to the building or its external environment. Moreover, since drying out can take a considerable time, a long-term programme of monitoring moisture content may be needed. This may be particularly important for buildings of historic interest or where the building has been severely wetted, eg as a result of flooding.



Figure 12 Hand-held electrical resistance meter

Techniques for determining moisture content

A range of techniques is available for determining the presence of moisture within building materials. The equipment required for some of the more advanced techniques is more suited to the test house or analytical laboratory and is not dealt with by this *Good Repair Guide*. The following techniques, however, are all well within the capabilities of the building

professional. In those situations where there is some doubt as to the source of moisture or where specific rather than comparative levels are required, these techniques provide detailed information to support both the visual and diagnostic evidence from site.

The techniques have been classified under three specific headings:

- | electrical resistance method,
- | drilling techniques,
- | environmental monitoring.

Assessing moisture in building materials

Good Repair Guide 33

Part 3: Interpreting moisture data

Charles Stirling
BRE Scotland

Moisture can enter buildings for many reasons and the resultant damage to materials and components is well documented. There is much published guidance on the identification and possible remedies for

moisture defects. The objective of this *Good Repair Guide* is to provide building professionals with examples of analytical techniques which could be used to supplement visual information in the identification of moisture

problems. The number of techniques is large so only a limited number can be reviewed. Part 3 gives advice on how to interpret the data from moisture and environmental data.

Other parts to this Guide

For Sources of moisture – see Part 1

For Measuring moisture content – see Part 2



Diagnosis and cure of dampness in basements can be complex

Considerable care is needed in the capturing and recording of moisture and environmental data to ensure that the potentially large amounts of information collected can be effectively manipulated and interpreted. A PC-based spreadsheet should be sufficient for most applications. By way of example, a typical data logger with 8 channels (four temperature

and four RH sensors), taking readings every 30 minutes for a period of one month will acquire around 12 000 readings. This is not a significant volume for modern computer processors. However, the operator needs to be confident in tracking and manipulating this amount of data.

Interpreting moisture content data

The moisture content level at which action is required or where there may be issues of durability varies between building materials. For example, timber moisture contents measured by electrical resistance, which are below 18%, are unlikely to be problematic. In contrast, masonry materials at this moisture level are likely to be close to saturation point.

Table 2 provides an indication of typical moisture levels and the actions required. The moisture levels indicated in Table 2 are not absolute values and should only be used as a rough, indicative guide. When assessing specific moisture content levels, reference should be made to recognised texts or manufacturer's technical data.

Good Building Guide

Building damp-free cavity walls

Barry Reeves and Chris Scivyer

Cavity walls should be built so that the inner leaf stays dry. Many building details are designed with this express purpose and are long-established. However, dampness is still a common problem in modern buildings, due to the faulty design or construction of damp-proofing measures or the wrong choice of material. This Good Building Guide gives guidance on how to ensure that new cavity walls do not suffer from dampness problems. It is aimed at architects and designers, engineers, site managers, house builders and masonry contractors, and replaces the guidance published in 1999.

Introduction

Several Good Repair Guides deal with rain penetration and rising damp in existing buildings. This Good Building Guide looks at ways of preventing the problems occurring in new cavity wall construction. In driving rain, water leaks through the outer leaf of most cavity walls, often in quite large quantities. Provided the damp-proofing measures are correctly designed and installed and the wall itself is reasonably free from defects, the water does not reach the inner leaf, but flows harmlessly down the cavity face of the outer leaf until it reaches the footings or is directed out of the cavity via cavity trays or window/door lintels.

Defects in the outer leaf

Most of the leakage through the outer leaf is at fully or partly filled joints between the bricks and the mortar. Good workmanship can help to prevent this; it is especially important to fill the perpends properly, although this is frequently not achieved in practice. This is particularly pertinent in areas of high exposure, where driving rain can be blown through wide joints and across the cavity via bridging features such as wall ties, mortar, displaced insulation batts or brick fragments to wet the inner leaf. The type of pointing also has an effect: 'bucket handle', weathered or struck pointing have the best resistance to driving rain (Figure 2). Recessed pointing, which allows water to



Figure 1: Damage to a ground-floor flat caused by rain penetrating the inner leaf of a cavity wall via a torn and debris-filled cavity tray to a cavity wall of a flat upstairs

Good Repair Guide

Diagnosing the causes of dampness

John Houston

Dampness of one sort or another is the most common problem in housing. It results in visible wetting of walls, ceilings and floors, blistering paint, bulging plaster, sulfate attack on brickwork and mould on surfaces and fabrics, usually accompanied by a musty smell. It can also lead to less obvious problems, eg thermal insulation is reduced in effectiveness or brickwork cracks because metal components embedded in it have corroded. As with all repair work, the first step to solving any damp-related problem is to diagnose the cause correctly. This Good Repair Guide provides advice on how to identify the potential causes of dampness in homes. It is aimed at housing professionals, home owners and occupiers, and replaces the guidance published in 1997. The other guides in the series, Good Repair Guides 6–8^[1, 2, 3], cover specific remedial treatment for the principal causes of dampness.

Introduction

Even in a 'dry' building, there is a surprising amount of water in porous materials, most of which does no harm. A building is only considered to be damp if the moisture becomes visible through discoloration and staining of finishes, or causes mould growth, sulfate attack, frost damage or even drips and puddles. All these signs can lead to deterioration in decorations and the fabric of the building. Damp problems are generally referred to as being of internal or external origin.

Internal dampness: moisture from condensation

Condensation usually disperses fairly quickly and is a source of only minor localised inconvenience. However, in homes that are poorly heated or inadequately ventilated, it can become a serious and persistent problem that causes mould to grow (Figure 1). This is a common situation in rented accommodation, but also occurs quite frequently in owner-occupied property: the households affected tend to be those that cannot afford



Figure 1: Typical example of mould caused by condensation

to heat their homes adequately. Although there is a common assumption that condensation is due to poor hygiene and maintenance, in fact new and refurbished homes that are more airtight and thermally efficient can also suffer with condensation problems.

It can be a complex task to determine the precise cause of condensation, but there are some distinctive features to look for when making an initial diagnosis:

- Condensation normally occurs only from autumn to early spring.
- Problems start on the coldest internal surfaces: external walls (particularly corners), single-glazed windows, wall-to-floor junctions, lintels and window reveals.
- Condensation occurs most often in rooms where lots of moisture is produced, eg kitchens and bathrooms, and also unheated rooms into which moisture can drift if doors are left open and washing is dried indoors.
- Condensation often concentrates in areas where air movement is restricted, eg behind furniture or inside cupboards on outside walls.
- Condensation is a common problem where flueless paraffin or butane heaters or unvented tumble driers are used, or where clothes are dried indoors.

Remedying condensation in domestic pitched tiled roofs

One of the most common and cost-effective ways of saving energy in houses is to insulate the roof space, usually by laying insulation between the ceiling joists. But adding insulation

increases the risk of condensation in the roof and can lead to damage to the contents of the loft, the insulation and possibly even the roof structure.

This Good Repair Guide describes how to find out whether a pitched tiled roof is at risk from condensation and how to minimise it.

Why condensation occurs in the roof space

Large amounts of water vapour are produced in houses, mainly in bathrooms and kitchens. Up to 30% of it can find its way into the roof space through holes in the ceiling, mostly through gaps round loft hatches and pipework. Smaller amounts get through gaps round light fittings and penetrate the ceilings themselves. When the warm air meets the cold surfaces in the roof space, the water condenses out into water droplets.

In recent years the risk of condensation in the roof has increased, due to a combination of factors. Houses are much better insulated and heated, so the air can hold larger quantities of water vapour and more finds its way into the roof space. Furthermore, the trend to higher levels of insulation means that roof spaces are colder. These factors combine to increase the risk of condensation. The best way of preventing this happening is to ventilate the roof space.

Current building regulations stipulate a minimum standard of roof ventilation and most modern roofs are properly ventilated. In many



Condensation in the roof space can lead to mould growth and rot in the timbers



Insulation packed into the eaves has blocked ventilation paths. When the insulation quilt was lifted it was saturated with water condensate

Treating condensation in houses

Good Repair Guide 7

Every winter millions of homes in the UK suffer from condensation. About two million of them are badly affected and experience widespread dampness, often leading to persistent mould growth on walls, fabrics, carpets, clothes and shoes. This can cause great anxiety to householders, and is a common cause of

complaint to landlords. In new homes, the Building Regulations are designed to provide the right conditions, and condensation is much less common in dwellings built since the mid-1980s. In refurbishment of older property, a great deal can be done to overcome the problem by selecting the right combination of

remedial measures. But condensation can occur even in an 'ideal home', and part of the remedy always lies in the hands of the householder. In some homes, the problem can be greatly reduced by the occupants adopting a more suitable pattern of heating, opening windows more often and using extract fans at the right time.

What causes condensation?

Every day the average UK household puts about 12 litres of moisture into the air in their home, through normal activities such as cooking, washing clothes and bathing; breathing alone contributes about 1 litre per person every 24 hours. In homes where clothes are dried indoors, or which use paraffin or bottled gas heaters, the total can be over 20 litres a day.

About half this moisture is produced slowly throughout the day in different rooms of the home. The remainder is produced over short periods of time and in large quantities, mainly in the kitchen and bathroom.

Even in warm, well-ventilated homes, moisture in the air can result in condensation during the winter: most people are familiar with the misting on the mirror after running a bath, or on the inside of single- and double-glazed windows on a cold morning. Usually condensation disperses fairly quickly and does not cause more than minor inconvenience.

But in homes which are poorly heated or inadequately ventilated, condensation is often serious and persistent, and leads to the growth



Condensation on inner face of double-glazed windows. Note ponding on sill

of mould. It is more common in rented accommodation, both private and public, but it can also occur in owner-occupied property. The households affected tend to be those that cannot afford to heat their homes adequately, or whose homes have high moisture loads from cooking, washing, drying clothes, etc.

Treating dampness in basements

Good Repair Guide 23

Several problems can be encountered following conversion of a basement in an older property into habitable accommodation: the most serious is probably dampness because early forms of basement construction had

no damp-proofing. Although basements used as kitchens and servants' rooms were reasonably dry, many others suffer from penetrating dampness, mould growth and deterioration of timbers. This is

unacceptable for habitable rooms. This Good Repair Guide gives advice to builders and householders on ways of treating dampness in basements by treating internal surfaces.

Converting a basement into living space is often a popular and profitable step in older houses. In addition to dampness, other problems may need to be tackled to comply with Building Regulations, including ventilation, thermal performance, lighting, fire protection, headroom and access, all of which can be more difficult to achieve in basements than in rooms above ground. You will need to consult the Building Control Officer at an early

stage about the specific requirements of the property, and you should also seek the advice of a building surveyor or structural engineer. In addition, you will have to consider the practicability of the proposed work and whether it can be done within your budget.

This *Good Repair Guide* deals only with damp-proofing and covers the choice of systems, the materials available and the detailing needed for treating internal surfaces.



Salts from dampness in the structure is one of the problems to be faced in converting a basement to living space

Treating rain penetration in houses

Good Repair Guide 8

good repair guide

It is **difficult** to be certain that dampness problems are **caused by rain penetration**: symptoms can be **misleading** and **sometimes more than one defect is involved**. Even if **rain penetration is the cause**, it can be **hard to pinpoint the exact route the water is taking**. For example, a damp patch on

a ceiling could be due to a missing tile some distance away; masonry in parapets and chimneys can collect rainwater and deliver it to other parts of the building below roof level; blocked gutters can lead to damp patches on walls that look as if rain is penetrating the wall.

This guide contains advice on diagnosing and remedying the problem. There is particular emphasis on rain penetration through walls because it can be particularly difficult to resolve.

Rain penetration through walls

Solid walls

In general, solid brick walls give satisfactory protection against rain penetration in areas of low exposure to wind-driven rain. When water does get through the wall, penetration is often linked with certain building features (see box).

Remedies for solid walls

If mortar joints are leaking, they should be raked back to a depth at least equivalent to the height of the joint, and repointed (though not by *recessed* pointing; see page 2, *Unfilled cavity walls*) using a mix compatible with the existing mortar and masonry unit.

For less exposed areas, applying a masonry water repellent can be inexpensive and can have a lifetime of up to 10 years on normal clay brickwork. Take care in the choice and application of the repellent, ensuring that the background is suitable to receive the treatment.

In areas of severe local exposure, walls can be rendered or given a protective cladding of tiles or slates. Rain penetration occurs most commonly on exposed gable ends, and partial cladding of these, ie down to first-floor level, may be sufficient.

In walls which are already rendered or clad, make good any defective detailing of joints round windows, doors, airbricks, etc, cracks in the render or defects in the cladding.

Examining solid walls

- | Are there cracks in any rendering or are any cladding details detached or defective?
- | Has the pointing deteriorated?
- | Are there any unweathered ledges, eg steps in unweathered chimney stacks, piers or projecting courses?
- | Are there defects in any sills, eg cracks, sills out of level, insufficient projection, blocked or absent throatings?
- | Are there any inadequate, damaged or blocked rainwater goods?
- | Are there any unprotected joints round windows, doors, air bricks and other components?
- | Have there been any changes in exposure of the wall, eg an adjacent building demolished, shelter trees removed?

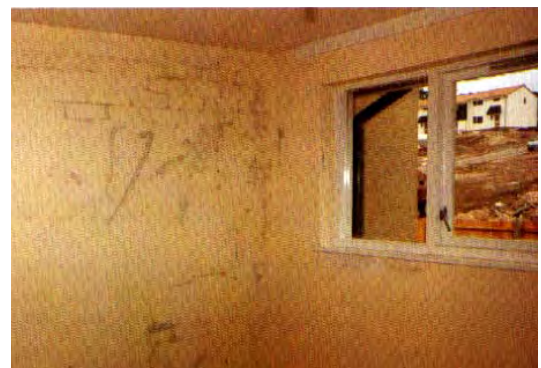

Rain penetration into a separating wall due to faulty flashing

Treating rising damp in houses

Good Repair Guide 6

good repair guide

Householders — and even some surveyors — are too quick to assume that problems with dampness

are caused by rising damp. In fact, true rising damp is not very common. Because the remedies for rising

damp are so expensive, it is doubly important to ensure the diagnosis is correct before starting work.

Rising damp in walls

Rising damp is the result of porous masonry sucking up water from the ground, rather like blotting paper. The water rises up the wall — sometimes to a height of a metre or more — and often leaves a characteristic horizontal 'tide mark'. Below this mark the wall is discoloured, with general darkening and patchiness, and there may be mould growth and loose wallpaper.

The amount of water absorbed by the wall, and the height it rises too, depends on the capacity of the masonry to absorb moisture, how wet the soil is, and how quickly moisture can evaporate. The water contains soluble salts (from the ground, or dissolved out of the bricks or mortar) and, as the water evaporates, the salts crystallise out on the wall surfaces, often concentrating in the tide mark.

Causes

The principal cause of rising damp is that the damp-proof course has *failed* or been *bridged* — eg by mortar inside a cavity wall — or *damaged*, perhaps during installation. The dpc may also have been specified or laid incorrectly.



Typical rising damp stain on an external wall. In this case, the dpc was bridged by the paving

What else could be causing the damp?

- | Rain penetration
 - | Condensation
 - | Leaking gutters or downpipes
 - | Plumbing defects
 - | Persistent spillages from, eg washing machines
 - | Construction water (in a new building)
 - | Water trapped in the building fabric while it was open to the weather (in a refurbished property)
 - | Hygroscopic salts, which may be left in the wall by a previous damp problem, and absorb moisture from humid air and leave damp patches on the wall.
- Hygroscopic salts **may or may not be** a sign of rising damp: they make diagnosis difficult by distorting moisture meter readings

For a more detailed discussion, see GRG 5.

Electrical, control and IT systems

Electrical, control and IT systems

Installing smart home digital networks

GG 77

SAMPLE

INSTALLING SMART HOME DIGITAL NETWORKS

Mike Perry

BRE's Innovation Park features a number of demonstration properties showcasing over 200 different innovative and emerging technologies and solutions that could have a significant impact on the economic, societal and environmental performance of the built environment. The digitally connected built environment is one of the most important emerging innovation themes on the Innovation Park. This Good Building Guide focuses on the key practical considerations for installing home digital networks, vital for the successful delivery of existing and future digital services.

WHAT IS A SMART HOME?

When people speak about smart home services, they frequently refer to digital services, and often mean access to the internet and home entertainment. They less commonly refer to voice over IP (VoIP, ie digital telephony) and home computer networks, or the suite of other digital service opportunities that are beginning to emerge (eg telecare services).

Currently, about 68% of the UK population can access broadband infrastructure which relies heavily, but not exclusively, on the use of PC-type technology to enable delivery of internet services. Overall, about 60% of the UK population with broadband access use the internet daily. Demand is growing, encouraged by the UK government which would like to see the capability to access broadband services in all UK homes.

At present, in most dwellings digital services enter the home and are accessed from a single point of entry, commonly an asynchronous digital subscriber line (ADSL) connection which is an upgraded telephone line capable of carrying both voice and data signals at high speeds, measured in mega bits per second (Mbps). The speed of data transmission is commonly referred to as the



bre press

bre

Energy and housing

Energy and housing

Improving energy efficiency Part 1: Thermal insulation

GR 26-1

Improving energy efficiency Part 2: Boilers and heating systems, draughtstripping

GR 26-2

SAMPLE

Improving energy efficiency: thermal insulation

Good Repair Guide 26

Part 1

A warmer house is a better house and it is never too late to insulate and take energy-efficient steps around the home to help use less fuel next winter. Improving the insulation of walls, roofs and ground

floors and upgrading existing heating systems will save energy. In addition to making a house warmer and cheaper to heat, insulation can lower the maintenance costs and give longer life to the

property. Part 1 of this Good Repair Guide suggests some ways of improving insulation. It will be of interest to householders and builders involved in refurbishment.

Other parts to this Guide

For upgrading the space heating and hot water system and draughtstripping – see Part 2

Today, buildings use up to half of all energy consumed in Britain. It is estimated that about £10 billion worth of energy every year is wasted in the UK – that's about half the total value of output each year from the North Sea. In addition to the worldwide issue of climate change, caused in part by the carbon dioxide emitted through the use of fossil fuels, there are good reasons to be interested in saving energy. The cost of energy is a significant proportion of the cost of running a home so using or wasting less energy makes sense. The cost of making a house more energy-efficient can be offset by lower fuel bills – it becomes a warmer house but less expensive to heat.

The sorts of insulation measures installed in new homes to meet current building regulations/standards are, for example, wall cavities filled with insulation material, insulation of ground floors, insulation of lofts with a 150 mm thick quilt, double-glazed windows with trickle vents, draughtstripping of outside doors, fitting of extract fans in bathrooms and kitchens.

Many of these improvements can also be made to the millions of older homes suffering badly from draughts and heat loss problems that have never been fully solved.

The benefits of a well-insulated house are:

- | more warmth in winter,
- | lower fuel bills,
- | much reduced risk of condensation and mould growth,
- | lower maintenance costs and longer life.

However, in the process of improving energy efficiency it is possible to do things that have unexpected and unwelcome consequences. The box below gives three important checks to avoid making mistakes.

Important checks when applying insulation

- | Check that insulation is being put in the right place; the vapour barrier should always be on the warm side of the insulation.
- | Check for the need to change or improve the way in which rain is stopped from getting through a wall.
- | Check for areas with less insulation than the rest (ie thermal bridges) since they are more likely to suffer from condensation and possibly mould growth.

For further information on avoiding problems as a result of adding insulation see BRE report *Thermal insulation — avoiding risks* and *Good Practice Guide 155*.

Improving energy efficiency: boilers and heating systems, draughtstripping

Good Repair Guide 26

Part 2

A warmer house is a better house and it is never too late to insulate and take energy-efficient steps around the home to help use less fuel next winter. Improving the insulation of walls, roofs and ground floors and upgrading

existing heating systems will save energy. In addition to making a house warmer and cheaper to heat, insulation can lower the maintenance costs and give longer life to the property.

Part 2 of this Good Repair Guide suggests some ways of upgrading central heating and reducing draughts. It will be of interest to householders and builders involved in refurbishment.

Other parts to this Guide

For insulating roofs, floors, walls, hot water cylinders and pipes – see Part 1

Main objectives in improving energy efficiency

- | Achieve good levels of insulation
- | Provide an efficient heating and hot water system
- | Substitute controlled ventilation for existing draughts

Note: not all the following measures improve energy performance to the same extent.

Providing an efficient space heating and hot water system

The requirements of an energy-efficient heating system are:

- | to be correctly sized,
- | to use fuel as efficiently as possible,
- | to be well controlled so that heat is provided only when and where needed.

In addition, householders appreciate the following features:

- | controls which are easy to use and understand,
- | reliability and easy maintenance.

The efficiency of the central heating boiler is a major factor affecting the energy efficiency of domestic central heating systems. Many improvements in boiler technology have been

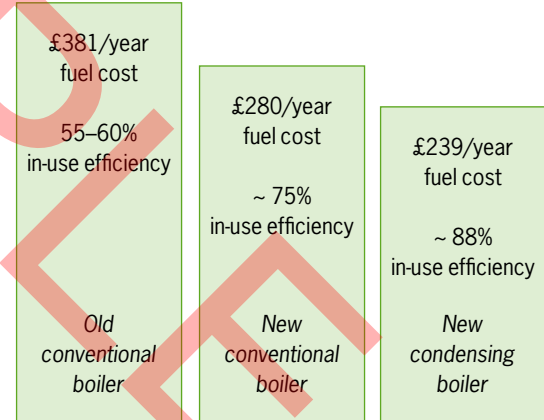

Comparison of fuel cost and boiler efficiency for gas central heating and hot water in a typical 3-bedroom semi-detached house

made in recent years, and when older boilers are replaced substantial efficiency improvements are achievable. The greatest energy efficiency benefits can be obtained from condensing boilers.

Condensing boilers

Condensing boilers are becoming an increasingly important choice when boilers are

Heating, insulation and air conditioning

Heating, insulation and air conditioning

Installing thermal insulation: Good site practice: Part 1

GG 68-1

Installing thermal insulation: Good site practice: Part 2

GG 68-2

SAMPLE

Installing thermal insulation: Good site practice

GBG 68 Part 1

This Good Building Guide gives practical help in the different methods of building insulation into each part of the house (eg ground floors, external walls, windows/doors and roofs). Deficiencies in detailing that allow air leakage and thermal bridging will cause condensation, mould growth and excessive energy use in the finished house. Following the advice in this Good Building Guide will result in a well-insulated house that is warmer to live in, cheaper to run and better for the environment.

Part 1 covers:

- General principles of preventing thermal bridging and air leakage,
- Ground floors,
- Pitched roofs and rooms-in-the-roof.

Part 2 covers:

- External cavity walls,
- Windows and doors,
- Further reading.



Reducing energy consumption, condensation and mould growth in homes, and environmental concerns mean that standards of thermal insulation in buildings have been improving. Consequently, standards in site practice and good workmanship are critical to achieving the expected performance from the finished house. Supervision and regular checking on site are essential to ensure that high standards of construction are achieved and technical risks such as air leakage and thermal bridging are minimised.

Technical risks of insulating cold roofs with a loft

- **Condensation** if there is insufficient ventilation through the loft space to remove moist air infiltrating from the dwelling below.
- **Thermal bridging** at the junction with the eaves and gable walls.
- **Insulation compressed** by access boarding when the depth of the ceiling joists is less than the insulation thickness.
- **Loss of thermal performance** where insulation is not fitted neatly between the ceiling joists or where there are gaps of generally more than 10 mm between the insulation and the plasterboard.

Technical risks of insulating ground floors

If insulating *above* or *below* a concrete slab:

- **Damage to moisture-sensitive floor finishes** where the slab has not been given enough time to dry out.
- **Chemical reaction** between liquid-applied dpm and insulation.

If insulating *below* a concrete slab:

- **Loss of thermal performance** where insulation materials have been specified that are neither sufficiently strong nor sufficiently resistant to moisture and/or ground contaminants.
- **Thermal bridging** at the edge of the floor and at the thresholds of external doors where insulation is missing or there is no overlap or continuity between wall and floor insulation.

If insulating *above* a concrete floor:

- **Failure in service** due to inadequate or uneven support, incorrect installation of flooring panels or the screed finish being insufficiently strong or thick.

And if insulating a *timber suspended floor*:

- **Loss of thermal performance** where insulation is not thick enough or there are gaps between insulation boards.
- **Interstitial condensation** due to inadequate subfloor ventilation.

Installing thermal insulation: Good site practice

GBG 68 Part 2

This Good Building Guide gives practical help in the different methods of building insulation into each part of the house (eg ground floors, external walls, windows/doors and roofs). Deficiencies in detailing that allow air leakage and thermal bridging will cause condensation, mould growth and excessive energy use in the finished house. Following the advice in this Good Building Guide will result in a well-insulated house that is warmer to live in, cheaper to run and better for the environment.

Part 1 covers:

- General principles of preventing thermal bridging and air leakage,
- Ground floors,
- Pitched roofs and rooms-in-the-roof.

Part 2 covers:

- External cavity walls,
- Windows and doors,
- Further reading.

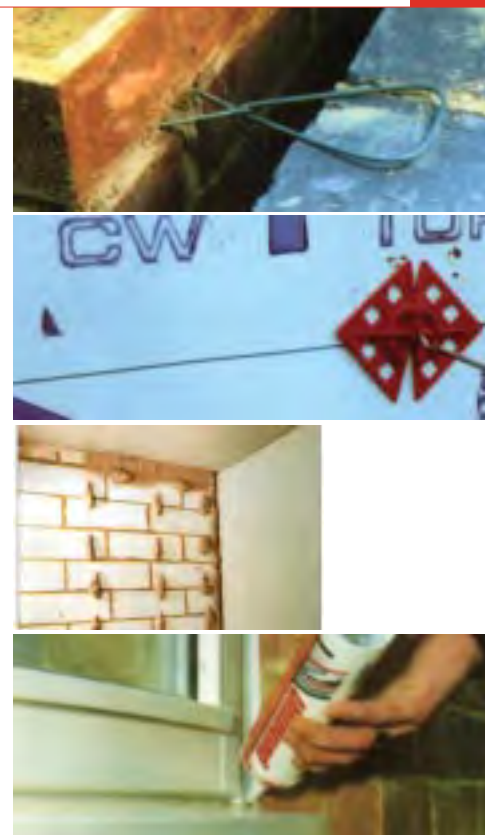

Technical risks of insulating external cavity walls

- **Rain penetration** if the wall:
 - is not adequately protected from wind-driven rain,
 - is not designed and constructed to the standards required by the national Building Regulations:
 - Approved Document C (England & Wales),
 - Section 3 (Scotland),
 - Technical Booklet C (Northern Ireland),
 - is used in a location that is too exposed for its construction.
 - **Thermal bridging** at reveals where windows and doors are built into the outer leaf and don't overlap an insulated cavity closer.
 - **Air leakage** around openings, where there are gaps through the inner leaf to the interior, eg where joists are built into the wall, where services and other components pass through and around the edges of a dry lining.
- In addition, if partial fill insulation is used:
- **Thermal performance** is reduced if external air can circulate behind the insulation.
- Or if the construction is a clear cavity with an insulated dry lining:
- **Interstitial condensation** if water vapour from within the dwelling finds its way through the dry lining to the colder masonry surfaces behind.
 - **PVC-insulated electrical cables** in contact with expanded polystyrene can have a reduced life expectancy.

Technical risks of insulating windows and doors

- **Rain penetration** if the window or door is not adequately detailed or protected from wind-driven rain.
- **Air leakage** where there are gaps between the frame and the wall, or around edges of a dry lining.
- **Thermal bridging** at reveals where a steel lintel has a continuous lower web or the window frame doesn't overlap an insulated lintel, cavity closer or sill.

Remember!

Good workmanship is a key factor in preventing heat loss, air leakage and rain penetration, and in achieving an energy-efficient house.

Lighting

Lighting

Lighting: Part 1: General principles

GG 61-1

Lighting: Part 2: Domestic and exterior

GG 61-2

Lighting: Part 3: Non domestic

GG 61-3

SAMPLE

Lighting: General principles

GBG 61 Part 1

BRE Environment

Lighting is of critical importance in all types of buildings. An adequate level and distribution of light is vital if visual tasks are to be carried out safely and effectively. Good lighting will also improve the internal environment and appearance of a building. The use of efficient lamps, ballasts and luminaires, with appropriate lighting controls, can provide the right visual environment, be energy efficient and cost effective. Part 1 of this Good Building Guide describes the general principles and gives an introduction to what is available.



Lighting scheme in a new factory unit, comprising metal halide lamps controlled in zones by manual switching. It uses high efficiency modern components and exploits natural and reflected light potential

General principles

Electricity for lighting is a major expense with significant environmental impact. It should be used to supplement daylighting as required, with local lighting for the more demanding visual tasks. When installing the lighting, ensure that light is directed to where it is needed.

There are three different types of lighting.

- General, eg a central hanging light,
- Task lighting, eg a desk or table lamp,
- Atmospheric or ornamental, eg wall lighting.

These are a few guidelines to help get your lighting right:

- Decide what the lighting is really needed for, then design your lighting scheme to position lights where they will be used. Use task lighting. Provide sockets for reading lamps.
- Use only lamps appropriate to the luminaire.
- Light for safety.
- Light for effect. Reduced background lighting levels create more contrast in a room and can save energy.

Box 1 Jargon buster

Ballast/control gear

Apparatus to start and control the current through fluorescent and other discharge lamps.

Diffuser

A translucent screen used to shield a light source and at the same time soften the light output and distribute it evenly.

Discharge lamp

A lamp whose illumination is produced by an electric discharge through a gas, a metal vapour or a mixture of gases and vapours.

Efficacy

A measure of the effectiveness of a lighting installation in converting electrical power to light (lumens/watt).

Lumen

Unit of luminous flux, used to describe the amount of light given by a lamp.

Luminaire

The term for a light fitting; it distributes light from a lamp and includes all components for fixing, protecting the lamps and connecting them to the electricity supply.

Lux

Unit of illuminance, or amount of light on a surface (lumens/m²).

Lighting: Domestic and exterior

GBG 61 Part 2

BRE Environment

Lighting is of critical importance in all types of buildings. An adequate level and distribution of light is vital if visual tasks are to be carried out safely and effectively. Good lighting will also improve the internal environment and appearance of a building. The use of efficient lamps, ballasts and luminaires, with appropriate lighting controls, can provide the right visual environment, be energy efficient and cost effective.

Part 2 of this Good Building Guide describes an internal domestic lighting scheme, exterior lighting and maintenance of luminaires and lamps, and provides a lighting design aide-memoire.

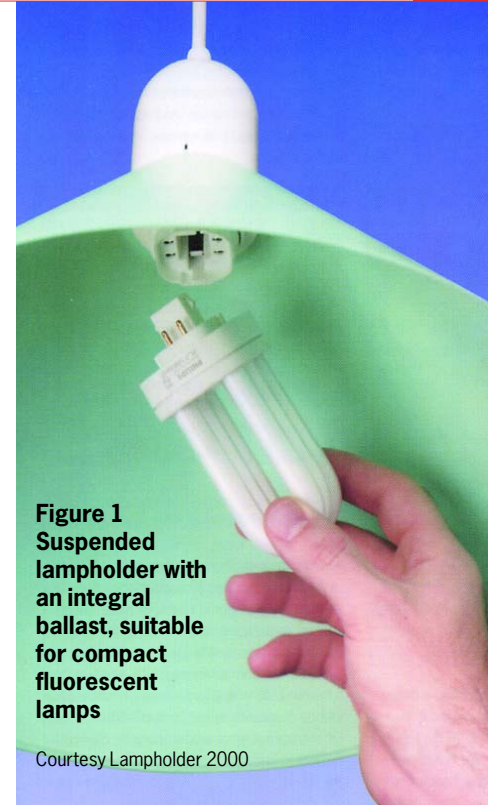

Figure 1
Suspended lampholder with an integral ballast, suitable for compact fluorescent lamps

Courtesy Lampholder 2000

Domestic lighting

In most homes, lighting accounts for 10–15% of the electricity bill. The 2002 revision of Part L requires that a proportion of lighting in new dwellings is energy efficient. In addition, exterior lighting must be fitted with sufficient controls so that energy is not wasted.

When designing a domestic lighting scheme some important principles are given in Box 2 and Figure 2.

To qualify as energy-efficient for Part L, luminaires should only take lamps with a circuit luminous efficacy of more than 40 lumens per watt, eg fluorescent tubes and compact fluorescent lamps (CFLs). A simple bayonet or Edison screw type of lampholder would not count, even if it was fitted with a self-ballasted CFL. This is to discourage the replacement of the lamp with a tungsten one. CFLs should be fitted where they will be on for a long time, eg hall, landing and lounge. Fluorescent tubes are a good choice for the kitchen.

Box 1 Jargon buster

Ballast/control gear

Apparatus to start and control the current through fluorescent and other discharge lamps.

Diffuser

A translucent screen used to shield a light source and at the same time soften the light output and distribute it evenly.

Discharge lamp

A lamp whose illumination is produced by an electric discharge through a gas, a metal vapour or a mixture of gases and vapours.

Efficacy

A measure of the effectiveness of a lighting installation in converting electrical power to light (lumens/watt).

Lumen

Unit of luminous flux, used to describe the amount of light given by a lamp.

Luminaire

The term for a light fitting; it distributes light from a lamp and includes all components for fixing, protecting the lamps and connecting them to the electricity supply.

Lux

Unit of illuminance, or amount of light on a surface (lumens/m²).

Lighting: Non-domestic

GBG 61 Part 3

BRE Environment

Lighting is of critical importance in all types of buildings. An adequate level and distribution of light is vital if visual tasks are to be carried out safely and effectively. Good lighting will also improve the internal environment and appearance of a building. The use of efficient lamps, ballasts and luminaires, with appropriate lighting controls, can provide the right visual environment, be energy efficient and cost effective. Part 3 of this Good Building Guide describes how to fulfill the lighting requirements of Part L2 in non-domestic buildings and how to follow good practice in energy efficient lighting for specific applications. Exterior lighting is covered in Part 2.

Low energy, high frequency lighting with automatic and local controls contributes to the low energy consumption of this office building



The Building Regulations

Part L2 requires that non-domestic buildings that are new or that have undergone a material change of use (eg a dwelling has become an office) or that have a material alteration (eg change in the structure) or that have a controlled service replaced (including lighting) should:

‘provide lighting systems which are energy efficient ... within buildings and parts of buildings where more than 100 m² of floor area is to be served with artificial lighting’

whether it is the whole building or part of it. Exterior lighting of non-domestic buildings is exempt from the requirements of Part L2. Portable lighting, emergency escape lighting and specialist process lighting (eg task lighting in a dentist’s surgery or a photographic studio) are also exempt.

Office, industrial and storage buildings

General lighting in offices, industrial and storage buildings would comply with a luminaire efficacy

Box 1 Jargon buster

Ballast/control gear

Apparatus to start and control the current through fluorescent and other discharge lamps.

Diffuser

A translucent screen used to shield a light source and at the same time soften the light output and distribute it evenly.

Discharge lamp

A lamp whose illumination is produced by an electric discharge through a gas, a metal vapour or a mixture of gases and vapours.

Efficacy

A measure of the effectiveness of a lighting installation in converting electrical power to light (lumens/watt).

Lumen

Unit of luminous flux, used to describe the amount of light given by a lamp.

Luminaire

The term for a light fitting; it distributes light from a lamp and includes all components for fixing, protecting the lamps and connecting them to the electricity supply.

Lux

Unit of illuminance, or amount of light on a surface (lumens/m²).

Radon and gas emissions

Radon and gas emissions

Radon protection for new domestic extensions and conservatories with solid concrete ground floors REVISED 2015	GG 73
Radon protection for new dwellings: REVISED 2015	GG 74
Radon protection for new large buildings REVISED 2015	GG 75
Radon solutions in homes : Part 1. Improving underfloor ventilation ventilation	GR 37-1
Radon solutions in homes : Part 2: Positive house ventilation	GR 37-2
Radon solutions in homes : Part 3. Radon sump systems	GR 37-3
Radon solutions in older homes	GR 38

Good Building Guide

Radon protection for new domestic extensions and conservatories with solid concrete ground floors

Chris Scivyer

The overall aim of this Good Building Guide is to give practical advice and guidance on the successful installation of radon-protective measures in new domestic extensions and conservatories with solid concrete ground floors. The guide will also help house owners and builders in radon-affected areas to assess whether protection is needed for a new extension or conservatory and to determine the level of protection that is required. It should be read in conjunction with BRE Report BR 211, *Radon: guidance on protective measures for new buildings*^[1]. This Good Building Guide replaces the guidance published in 2008.

Two companion Good Building Guides^[2,3] cover radon-protective measures for new dwellings and new large buildings (eg workplaces).

What is radon and why consider it for new extensions?

Radon is a natural colourless, odourless, radioactive gas. It is formed by the radioactive decay of the small amounts of uranium that occur naturally in all rocks and soils. The gas can move through cracks and fissures in the subsoil and eventually to the atmosphere. Most of the radon will disperse harmlessly into the outdoor air, but some will pass from the ground and collect in spaces under or within buildings.

For most UK residents, radon accounts for half of the annual radiation dose received. Exposure to particularly high levels of radon may increase the risk of developing lung cancer. While it is recognised that the air inside every building contains radon, some buildings in certain defined areas of the UK might have unacceptably high concentrations unless precautions are taken. South-west England is of principal concern, but high concentrations of radon are also found in many other areas.

Extending an existing house will increase the area of the building that is in contact with the ground. The larger the footprint, the more chance there is that radon will enter from the ground. By



Figure 1: A typical conservatory to an existing property

protecting the new extension this effect can be minimised. In addition, if both the existing house and the new extension have a solid concrete ground floor, a means of reducing the radon level across both the new and existing parts of the building can be provided by installing a sump beneath the extension. With careful design and construction, radon-protective measures can be included relatively easily and cost-effectively within new extensions.

UK building regulations

This Good Building Guide supports building regulation guidance found in the following publications, which relate to specific UK regions:

- England: The Building Regulations 2010 (England). Approved Document C: Site preparation and resistance to contaminants and moisture^[4].
- Wales: The Building Regulations 2010 (Wales). Approved Document C: Site preparation and resistance to contaminants and moisture^[5].
- Scotland: The Building (Scotland) Regulations 2004. Technical Handbook: Domestic. Section 3: Environment^[6].

Good Building Guide

Radon protection for new dwellings

Chris Scivyer

The overall aim of this Good Building Guide is to give practical advice and guidance on the successful installation of radon-protective measures in new dwellings. It should be read in conjunction with BRE Report BR 211, *Radon: guidance on protective measures for new buildings*^[1]. This Good Building Guide replaces the guidance published in 2008.

Two companion Good Building Guides^[2,3] cover radon-protective measures for new domestic extensions and conservatories and new large buildings (eg workplaces).

What is radon and why consider it for new dwellings?

Radon is a natural colourless, odourless, radioactive gas. It is formed by the radioactive decay of the small amounts of uranium that occur naturally in all rocks and soils. The gas can move through cracks and fissures in the subsoil and eventually to the atmosphere. Most of the radon will disperse harmlessly into the air outside, but some will pass from the ground and collect in spaces under or within buildings.

For most UK residents, radon accounts for half of the annual radiation dose received. Exposure to particularly high levels of radon may increase the risk of developing lung cancer. While it is recognised that the air inside every building contains radon, some buildings in certain defined areas of the UK might have unacceptably high concentrations unless precautions are taken. South-west England is of principal concern, but high concentrations of radon are also found in many other areas.

Requirements for radon protection

Building regulations covering radon-protective measures for new dwellings in the UK were first introduced for south-west England in the late 1980s, for Derbyshire and Northamptonshire in the early 1990s and for the rest of England, Scotland and



Figure 1: Steps and staggers in construction make it difficult to provide a continuous radon barrier

Northern Ireland in the late 1990s. The gradual introduction of measures reflected the way in which the UK was mapped, targeting the worst-affected areas first.

Before the introduction of the requirements, BRE (funded by the Department of the Environment (DOE), which was the UK government department responsible at that time for radon-related issues) undertook an extensive series of field trials to demonstrate the effectiveness of the proposed protective measures. This was supported by a series of training seminars for architects, designers, developers, builders and building control officers. Most of the trials were undertaken in south-west England where DOE, through the National Radiological Protection Board (now Public Health England or PHE), was actively raising awareness of the risks of radon to householders through a major measurement programme. This meant that radon was in the news locally and it was seen as a new issue that the construction industry was willing, within reason, to deal with. The field trials proved successful and the requirements

Good Building Guide

Radon protection for new large buildings

Chris Scivyer

The overall aim of this Good Building Guide is to give practical advice and guidance on the successful installation of radon-protective measures in new large buildings (eg workplaces). It should be read in conjunction with BRE Report BR 211, *Radon: guidance on protective measures for new buildings*^[1]. This Good Building Guide replaces the guidance published in 2009.

Two companion Good Building Guides^[2, 3] cover radon-protective measures for new domestic extensions and conservatories and new dwellings.

What is radon and why consider it for new large buildings?

Radon is a natural colourless, odourless, radioactive gas. It is formed by the radioactive decay of the small amounts of uranium that occur naturally in all rocks and soils. The gas can move through cracks and fissures in the subsoil and eventually to the atmosphere. Most of the radon will disperse harmlessly into the air outside, but some will pass from the ground and collect in spaces under or within buildings.

This Good Building Guide should be read in conjunction with the guidance contained in *Radon: guidance on protective measures for new buildings*

For most UK residents, radon accounts for half of the annual radiation dose received. Exposure to particularly high levels of radon may increase the risk of developing lung cancer. While it is recognised that the air inside every building contains radon, some buildings in certain defined areas of the UK might have unacceptably high concentrations unless precautions are taken. South-west England is of principal concern, but high concentrations of radon are also found in many other areas.



Figure 1: General view of a radon barrier laid over fill and sealed to columns

Requirements for radon protection

Building regulations

Building regulations covering radon-protective measures in the UK were first introduced for south-west England in the late 1980s, for Derbyshire and Northamptonshire in the early 1990s and for the rest of England, Scotland and Northern Ireland in the late 1990s. Initially, protective measures were only required in new dwellings, but more recently the requirements have been extended to include all building types, extensions, conversions and major alterations in areas affected by radon. The BRE guide *Radon: guidance on protective measures for new buildings* (BR 211)^[1] was published as supporting guidance to the various UK regional building regulations^[4, 5, 6, 7, 8]. This guide has been updated several times, with the latest edition due to be published in 2015.

RADON SOLUTIONS IN HOMES

Improving underfloor ventilation

Chris Scivyer

This Good Repair Guide offers guidance to builders and homeowners carrying out installation works to increase ventilation under suspended ground floors. It covers the installation of both natural and mechanical (fan-assisted) ventilation to underfloor spaces. Advice is also given on system maintenance and what to do if a system fails to adequately reduce radon levels.

This Good Repair Guide is Part 1 in a 3-Part set and replaces the guidance given in BRE Report BR 270. Parts 2 and 3 cover positive house ventilation and sump systems.

BACKGROUND Radon

Radon is a naturally occurring radioactive gas that is present in all buildings. Prolonged exposure to high levels causes lung cancer. The Health Protection Agency (HPA) recommends that householders with concentrations above the action level (200 Bq m^{-3}) should reduce their radon concentrations as far as they can and ideally to below the target level (100 Bq m^{-3}).

Improving underfloor ventilation

If part, or all, of the ground floor is of suspended timber construction, improving underfloor ventilation may be an appropriate method for reducing indoor radon levels. Suspended timber floors should be well ventilated to reduce the risk of timber rot and musty smells. Ideally, there should be vents in the walls on either side of the floor to encourage cross-ventilation and minimise dead areas beneath the floor (Figure 1). Improving underfloor ventilation to reduce radon levels therefore also benefits the floor in other ways.

Locating airbricks on the opposite sides of the underfloor space allows for complete cross ventilation

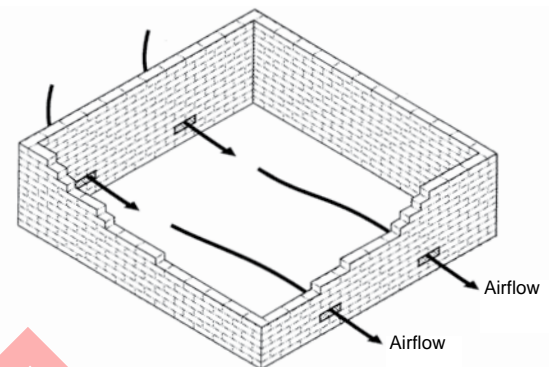

Poorly located airbricks cause areas of poor ventilation (dead areas)

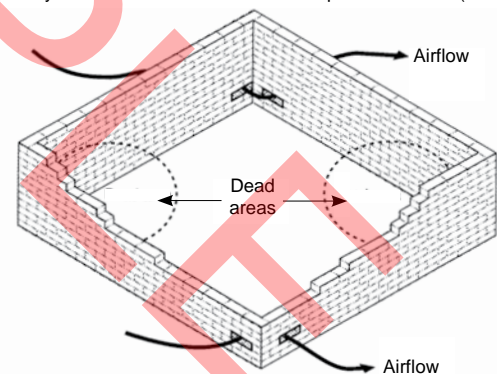

Figure 1: Examples of (a) good ventilation (b) poor ventilation

Improved natural underfloor ventilation is generally effective for radon levels up to 500 Bq m^{-3} . It may be effective with higher levels but if not an underfloor fan could be added later. Often with higher levels, mechanical underfloor ventilation (using a fan) or an alternative solution will be required.



RADON SOLUTIONS IN HOMES

Positive house ventilation

Chris Scivyer

This Good Repair Guide offers guidance to builders and homeowners installing positive ventilation systems in homes. When controlled ventilation is provided to a house, indoor radon levels can be reduced and at the same time the indoor environment can be improved by reducing condensation, mould, stuffiness and stale odours. Advice is also given on system maintenance and what to do if a system fails to adequately reduce radon levels.

This Good Repair Guide is Part 2 in a 3-Part set and replaces the guidance given in BRE Report BR 281. Part 1 covers underfloor ventilation and Part 3 covers radon sump systems.

BACKGROUND

Radon

Radon is a naturally occurring radioactive gas that is present in all buildings. Prolonged exposure to high levels causes lung cancer. The Health Protection Agency (HPA) recommends that householders with concentrations above the action level (200 Bq m^{-3}) should reduce their radon concentrations as far as they can and ideally to below the target level (100 Bq m^{-3}).

What is positive ventilation?

Positive ventilation systems blow fresh filtered air into a property. Most systems comprise a fan unit located in the roof space (Figure 1). The air usually enters through a diffuser in the ceiling of the hallway or at the top of a stairway. The fan units should run continuously to effectively reduce radon concentrations. For properties without a roof space, such as flats and apartments, wall-mounted units are available (Figure 2).



Figure 1: Roof-located positive ventilation system



Figure 2: Wall-mounted positive ventilation system

Where can positive ventilation systems be used?

Positive ventilation systems are one of the least disruptive radon remedial measures to install. The systems are likely to work best:



RADON SOLUTIONS IN HOMES

Radon sump systems

Chris Scivyer

This Good Repair Guide offers guidance to builders and homeowners installing radon sump systems in homes. It covers the installation of both active (fan-assisted) and passive sump systems. Advice is also given on system maintenance and what to do if the system fails to adequately reduce radon levels.

This Good Repair Guide is Part 3 in a 3-Part set and replaces the guidance given in BRE Report BR 227. Part 1 covers underfloor ventilation and Part 2 covers positive house ventilation.

This guide is split into three sections:

- introduction to radon and sump systems
- guidance on installing sump systems, including worksheets
- maintaining systems and what to do if a sump system does not reduce radon levels sufficiently.

BACKGROUND Radon

Radon is a naturally occurring radioactive gas that is present in all buildings. Prolonged exposure to high levels causes lung cancer. The Health Protection Agency (HPA) recommends that householders with concentrations above the action level (200 Bq m^{-3}) should reduce their radon concentrations as far as they can and ideally to below the target level (100 Bq m^{-3}).

Where can sump systems be used?

These systems can be used on any building where:

- there is a capping over the ground, such as a concrete groundbearing slab
- there is concrete capping to the soil beneath a suspended timber floor
- a standby sump was provided during construction (in newer homes); see pages 2 and 6.

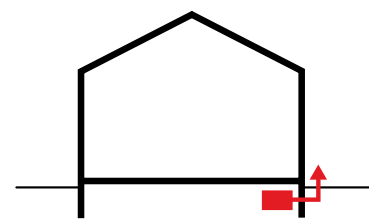

Externally constructed sump with low-level exhaust

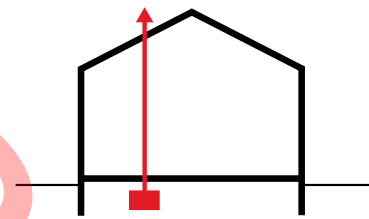

Internally constructed sump with high-level exhaust

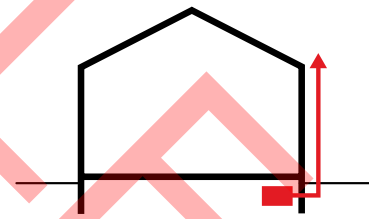

Externally constructed sump with high-level exhaust

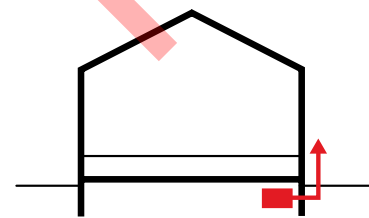

Externally constructed sump with low-level exhaust to a timber floor with concrete capping to the soil below

Figure 1: Generic sump systems



Good Repair Guide

Radon solutions in older homes

Chris Scivyer

This Good Repair Guide provides guidance to builders and homeowners carrying out installation works to reduce indoor radon levels in older homes. It describes the different construction features found in these properties and explains how commonly used radon remedial measures can be tailored to suit older buildings, including those that are listed buildings or located within conservation areas.

This Good Repair Guide supplements the guidance given in Good Repair Guides 37/1, 37/2 and 37/3.

Background

Radon is a naturally occurring radioactive gas that is present in all buildings. Prolonged exposure to high levels causes lung cancer. Public Health England (PHE) (formerly HPA) recommends that householders with concentrations above the action level (200 Bq m⁻³) should reduce their radon concentrations as far as they can and ideally to below the target level (100 Bq m⁻³).

Since the late 1980s, when advice on radon was first launched, many thousands of homes and workplace buildings across the UK have had radon solutions fitted to reduce indoor radon levels. Solutions have been successfully installed in all types and ages of properties.

It should be noted that BRE cannot guarantee that the measures described in this guide will reduce the radon level in a home; however, similar measures have regularly proven successful in homes elsewhere in the UK.



Figure 1: Typical old stone cottage

Many people assume that radon reduction measures will not work in older buildings, or if they do work then the cost will be prohibitive. By discussing different construction features of older buildings and their impact upon radon and the choice of solutions, this guide shows that:

- older properties can be remedied without adversely affecting their aesthetics or potential resale value
- remedial measures should not be significantly more expensive for older properties
- older properties can be remedied without causing structural damage (Figure 1)
- listed buildings or buildings located within a conservation area can, and have, been remedied.

Ventilation and air quality

Ventilation and air quality

Carbon monoxide detectors
Improving ventilation in housing

GG 30
GR 21

SAMPLE

Carbon monoxide detectors

GBG 30

Dr David Ross

BRE Healthy Building Centre

The use of combustion appliances in the home can generate levels of carbon monoxide (CO) that may affect the health of the occupants. Each year,

about 60 accidental deaths occur in the UK from the use of these appliances and there are many more non-fatal incidents.

This Good Building Guide

makes recommendations for locating a CO detection system in the home, based on requirements for early detection, audibility and the need to minimise cost.

A selection of detectors

Detectors, alarms and systems

CO detector

a device which sounds an integral alarm (such as a siren) and provides a visual warning when it detects CO concentrations above an acceptable level.

Repeater alarm

a device comprising an alarm (such as a siren) that operates when triggered by a separate CO detector to which it is connected. It does not itself detect CO concentration.

CO detection system

a system comprising one or more CO detectors; it may also include one or more repeater alarms.



Improving ventilation in housing

Good Repair Guide 21

Without enough ventilation, homes regularly suffer from condensation on windows, walls and floors. For well over 20 years, more widespread use of central heating, making windows and doors more airtight, installing sealed double glazing, sealing of open chimneys and flues have made it necessary to change the way existing

houses are ventilated. In the last 10 years or so, major changes in the way new homes are ventilated have been reflected in updates to building regulations — the most recent in England and Wales came into effect in July 1995 as an amended Approved Document F1. Refurbishment gives an opportunity for improving

ventilation in existing housing so the builder and householder need to be aware of the guidance given by local building regulations. This Good Repair Guide explains the changes to Approved Document F1 and gives advice on avoiding some of the problems that can confront the builder.



Without enough ventilation, homes regularly suffer from condensation on windows, walls and floors

Buildings need ventilation for three main reasons:

- l to get rid of the water vapour generated in the home by washing, cooking and just plain breathing, in order to avoid condensation and consequent mould growth,
- l to remove odour, and
- l to remove indoor air pollutants from paints, carpets, furniture, cleaning agents, etc.

There was a time when houses were generally better ventilated: in addition to general leakage, fresh air got in around windows and doors, and the flues of open fires ensured a continual through-flow of air. Increased

emphasis on energy saving has led to a growing use of draught-stripping and the replacement of old windows. The almost universal installation of central heating and widespread use of balanced flue (room sealed) gas boilers means that many houses have no flues and that old flues are sealed up. Anxiety about maintaining security when windows are left open can make the situation even worse.

As a result of all these trends, much less uncontrolled fresh air now gets into homes and, in spite of better heating levels, many modern homes suffer from insufficient ventilation and condensation is a common problem.

Water supply, drainage and sanitation

Water supply, drainage and sanitation

Below ground drainage systems	GG 78
Dealing with noisy plumbing	GR 32
Disposing of rainwater	GG 38
Gravity drainage systems for buildings	GG 76
Protecting pipes from freezing	GG 40
Provision of sanitary appliances and their space requirements	GG 79
Reed beds: Part 1. Application and specification	GG 42-1
Reed beds: Part 2. Design, construction and maintenance	GG 42-2
Repairing and replacing rainwater goods	GR 9
Water services for domestic properties	GG 80
Rainwater harvesting for domestic properties	GG 82

BELOW-GROUND DRAINAGE SYSTEMS

Peter Trotman* and John Griggs+

*BRE Associate, +Chartered Institute of Plumbing and Heating Engineering

This Good Building Guide gives recommendations for below-ground drainage systems serving sanitary appliances in low-rise and high-rise dwellings, office buildings and public buildings. It does not cover systems for more specialised equipment for buildings such as hospitals, laboratories and factories. Above-ground drainage (see Good Building Guide 76^[1]) should be designed before below-ground drainage so that the wastewater loadings determined for the above-ground system can be used in the design of the below-ground systems. Similar design principles apply to suspended horizontal pipework, for example, in a basement.

Wherever possible, a drainage system should be designed to operate by gravity (see BS EN 752^[2]). However, where this is not appropriate or is uneconomical, then alternatives include pumped discharges or vacuum or pressure systems. Situations where non-gravity systems will need to be considered include:

- high water tables
- contaminated land
- mountainous countryside
- settlements separated by rivers
- supermarkets
- buildings above tunnels
- sites where gravity systems would result in pipework with negligible or back (negative) falls.

The appropriate British Standards for alternative drainage systems include BS EN 121091^[3], BS EN 1671^[4] and BS EN 12056-4^[5].

The Public Health Act 1936^[6] defines a drain as a pipeline that serves only one property and a sewer as a pipeline that serves two or more properties. Also a drain will have intermittent wastewater flow whereas a sewer is more likely to be flowing continuously.



If water-conserving appliances are to be used in buildings there could be some impact on the drainage systems. BRE *Information Paper* IP 1/04^[7] sets out the principles of designing drain and sewer systems for low-water-use dwellings.

PERFORMANCE REQUIREMENTS

The basic requirement for an underground drainage system is to convey foul water and rainwater from the base of a drainage stack or drain gullies to an outfall (a foul or combined drain or sewer, a cesspool, septic tank or other type of individual wastewater treatment plant). Only gravity systems are discussed in this *Good Building Guide*. Box 1 lists the key performance requirements.



bre press



bre

Dealing with noisy plumbing

Good Repair Guide 32

good repair guide

Noise in plumbing and heating systems is best avoided by getting the design and installation right in the first place. But there are ways of reducing

noise in existing systems. This Good Repair Guide looks at some typical problems and suggests practical solutions.

People living in semi-detached or terraced properties, in flats or multi-occupancy dwellings are often annoyed by noise from their neighbour's plumbing. In fact, the Institute of Plumbing has recently reported a spate of calls about noise transmitted from next door neighbours' pipework. Complaints are likely to increase with the trend towards lightweight constructions, and as mains-fed water systems become more common.

Surveys suggest that people living in detached properties are usually prepared to live with noise from their own plumbing and heating systems. But there are still occasions when plumbing noise becomes a nuisance and professional help is called. The most common complaints are about noise from filling cold water storage cisterns and WC cisterns, flushing WCs, water hammer, and noise from water flow in pipes.

Storage cisterns

Cistern filling noises are particularly annoying at night. The noise is a combination of water pouring from the inlet valve onto the surface of the water in the tank and turbulence at the valve. The former is especially noisy now that 'silencing pipes' are not used.

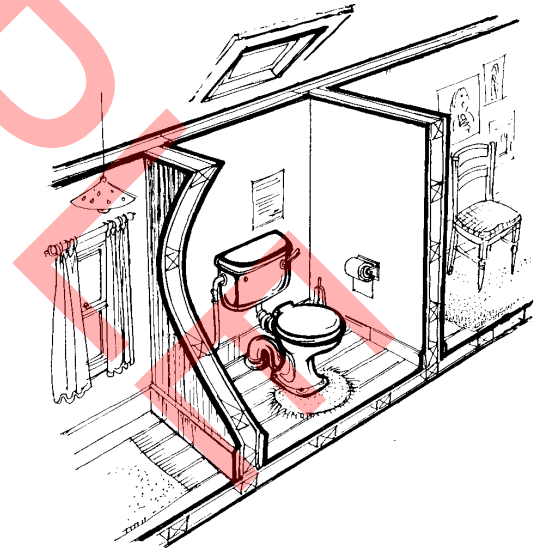

WC noise is one of the commonest causes of annoyance

Remedies

It may be possible to fit a quieter float operated valve, replacing a BS 1212 Type 1 valve with Type 2 or 3, but all valves must discharge above water level to prevent back siphonage (see BS 1212 and Water Supply (Water Fittings) Regulations).

Disposing of rainwater

GBG 38

Getting rainwater off the roof, down to the ground and away from the building is not always as simple as it seems. All the rain falling on the building has to be led down to ground level

without spilling, and into a below-ground drainage system. And that system has to be able to cope with potentially large and sudden influxes of storm water.

This Good Building Guide shows how to avoid some common pitfalls in roof drainage systems and soakaways for new housing.



Several defects in the roof drainage are contributing to this damp wall — the downpipe is missing, the gutter slopes the wrong way and is probably undersized for the large area of roof draining into it

BRE surveys have revealed a surprising number of faults in the design and installation of gutters and downpipes. These include undersized or missing gutters, insecure fixings, incorrect falls or even back-falls, and plastics gutters and downpipes that have sagged.

Downpipes are often badly positioned, which makes them needlessly complicated, or wrongly sited relative to gullies. Bad positioning can also impede opening of windows, risking damage to both pipes and windows.

GRAVITY DRAINAGE SYSTEMS FOR BUILDINGS

Peter Trotman and John Griggs

This Good Building Guide gives recommendations for above-ground drainage systems serving sanitary appliances in low- and high-rise dwellings, office buildings and public buildings. Systems in these types of buildings do not generally require additional ventilation pipework. This Guide does not cover systems for buildings such as hospitals, laboratories and factories where there is more specialised equipment. For these and more complex systems see BS EN 12056-2^[1]. This Guide does not deal with below-ground drainage systems which are covered in BS EN 752^[2].

PERFORMANCE REQUIREMENTS

Wastewater (other than rainwater and storm water) may be divided into two categories, reflecting the treatment that is necessary before re-use or discharge:

- greywater is wastewater not containing faecal matter or urine, and
- blackwater is wastewater containing faecal matter or urine.

Greywater from baths, basins, sinks and washing can be treated, recycled and used for WC flushing, as part of a water conservation strategy. However, greywater recycling is not covered in detail in this *Good Building Guide*; further information on greywater recycling can be found in BRE Information Paper IP 9/08 Part 3^[3]. The term 'foul water' when used in this *Guide* means blackwater and unrecycled greywater.

The basic requirements for an above-ground foul water gravity drainage system are to:

- convey the foul water to a below-ground system and hence to an outfall (a foul or combined drain or sewer, a cesspool, septic tank or holding tank),
- prevent foul air in the drainage system from entering the building under normal operating conditions*.



To fulfil these requirements the system should:

- have a means for ventilation,
- minimise the risk of blockage or leakage,
- be accessible for clearing blockages.

It should not:

- make the building more vulnerable to flooding,
- generate excessive noise.

* Fumes from foul water systems may contain chemicals including hydrogen sulfide, carbon monoxide, carbon dioxide and methane, the cocktail being noxious and odorous or odourless.



Protecting pipes from freezing

BRE Water Centre

Each winter a spell of exceptional cold weather catches a lot of builders and householders napping, resulting in frozen water supplies, burst pipes and consequent building damage. This is the time to

think about taking steps to prevent a repeat performance. The cost of repairing the damage caused by water from a burst pipe is out of all proportion to the cost of installing protection.

This *Good Building Guide* looks at how to prevent freezing of water supplies, inside and out, with advice for both new and existing buildings.

How to prevent pipes from freezing

Preventing freezing of water pipes is not difficult or expensive. The cost of repairing the damage caused by water from a burst pipe is out of all proportion to the cost of installing protection.

All cold water fittings located within the building but outside the thermal envelope or those outside the building should be protected against damage by freezing. Pipes and fittings installed in rooms that are adequately heated are not at risk. It is pipes above ground or in unheated and hidden parts of the house that are at risk, and these are also the places to check when improving the insulation of water supply and distributing pipes in existing installations. Any pipes or fittings that are exposed to freezing conditions should be adequately insulated.

This *Good Building Guide* looks at how to prevent freezing of water supplies, inside and out, with advice on both existing and new buildings. No amount of insulation on pipes inside a building will prevent them freezing, eventually, if the building is unheated. Insulation only slows down the escape of heat from pipes – if there is no heat and if exposed



The cost of damage caused by water from a burst pipe is often out of all proportion to the cost of protection from freezing

to freezing conditions for sufficient time, insulated pipes are as prone to freezing as uninsulated ones. *So if a building is to be left unheated for 24 hours or more in very cold weather, the water supply system must be drained to avoid freezing.*

Remember too that, in cold weather, water reaching the building from the mains may not be much above freezing point, so only a small reduction in temperature can lead to freezing. This is particularly likely where the pipes and fittings are of small diameter.

PROVISION OF SANITARY APPLIANCES AND THEIR SPACE REQUIREMENTS

Peter Trotman* and John Griggs+

*BRE Associate, +Chartered Institute of Plumbing and Heating Engineering

Sanitary appliances found within buildings include WCs, washbasins, baths or showers, sinks, urinals and bidets. In addition, water-using appliances such as washing machines and dishwashers may also be specified and installed. The numbers of appliances required within a building will depend on its use. Mandatory requirements are contained in the building regulations^[1-3] and Workplace (Health, Safety and Welfare) Regulations^[4] with guidelines for scale of provision for a wide variety of buildings given in BS 6465-1^[5]. Additional guidance on the strategy and provision of public toilets is given in BS 6465-4^[5]. Some guidance is given for special design of sanitary facilities for people with disabilities in BS 8300^[6] and BS 6465-4^[5].

This Good Building Guide also illustrates space requirements for bathrooms designed to give the minimum activity space for each appliance for personal use or for households with children, ie enough space for an adult to supervise the bathing and washing of children. Further guidance on space requirements for bathrooms and other locations is provided in BS 6465-2^[5].

PROVISION OF APPLIANCES

While use of most appliance provision will be at the occupier's convenience, WC provision should be such that a person can visit the WC quickly when necessary to avoid distress or health problems. The level of provision is based on studies which show that men take an average of 35 seconds to use an urinal, while a woman takes an average of 90 seconds to use a WC. Recommendations are given such that adequate provision is made to avoid people normally having to queue.

A range of building types is covered and it will be seen that the need for appliances for a shopping mall,



where usage is continuous, is very different from a theatre where all the usage will mainly come at an interval in a performance. The tables in the following sections give minimum recommended provision of each appliance.

Private dwellings

Minimum provision is given in Table 1. A WC with washbasin should be provided on the entrance storey, or

Table 1: Minimum provision of sanitary appliances in a private dwelling

Reproduced from BS 6465-1: 2006^[5] by permission of BSI*

Sanitary appliance	No. of sanitary appliances per dwelling	Remarks
WC	1 for up to 4 persons, 2 for 5 persons or more	There should be a washbasin in or adjacent to every WC
Washbasin	1	
Bath or shower	1 per 4 persons	
Kitchen sink	1	

* Details of how to obtain BSI publications are given on page 8.



Reed beds: application and specification

GBG 42

Part 1

John Griggs*, Nick Grant§

* BRE Water Centre

§ Elemental Solutions (Hereford)

The proposed revised Part H2, of the Building Regulations (England and Wales), and the proposed new Part M of the Technical Standards for compliance with the Building Standards (Scotland) Regulations 1990, as amended, both make reference to reed bed systems for treating

domestic wastewater. This Guide provides guidance to support building regulation requirements, describing typical applications and current accepted minimum design specifications for reed beds treating settled domestic wastewater. Part 1 of this Guide describes the historical

development of the various reed bed systems along with some of the current variations in design. It also covers the expected performance of such systems, and their application. Part 2 deals with designing, constructing and maintaining reed beds.

All biological sewage treatment systems rely on natural processes and organisms, and many apparently 'natural systems' rely on mechanical pumping and aeration. According to Reed et al (1990), what differentiates a 'natural treatment system' from others is that the processes proceed at 'natural' rates, thus limiting the major energy input to liquid transport, partial aeration and plant harvest when applicable. Mechanical systems such as trickling filters, which rely solely on gravity and natural processes, can have a lower energy input than *apparently* natural systems such as aerated ponds or Living Machines™ (Grant & Morgan 1999, Brix 1998).

Reed beds are known by various names and acronyms – see boxes on page 2 for explanation and glossary of terms.

Vertical flow systems (VFS)

The vertical flow reed bed as an engineered concept (as opposed to something found in nature) is generally accredited to the Max Planck Institute at Krefeld in Germany. Their systems actually used a combination of vertical and horizontal flow beds and this arrangement is sometimes called the Max Planck Institute



**One of the first vertical flow reed bed systems in the UK designed by Burka at Oaklands Park, Gloucestershire (Burka & Lawrence 1990)
© Elemental Solutions**

(or Krefeld) Process (MPIP) (Seidel 1978). Variations have also been called Aquatic Plant Treatment Systems (Burka & Lawrence 1990) and Hybrid Systems (Cooper 1999).

In the vertical flow reed bed the wastewater passes down through layers of free-draining sand and gravel (Figure 1). There are usually two or more beds side by side allowing a regime of rest and loading so that the surface, which becomes clogged in use, can recover its permeability (Figure 2).

Reed beds: design, construction and maintenance

GBG 42

Part 2

John Griggs*, Nick Grant§
* BRE Water Centre
§ Elemental Solutions (Hereford)

The proposed revised Part H2, of the Building Regulations (England and Wales), and the proposed new Part M of the Technical Standards for compliance with the Building Standards (Scotland) Regulations 1990, as amended, both make reference to reed bed systems for treating

domestic wastewater. This Guide provides guidance to support building regulation requirements, describing typical applications and current accepted minimum design specifications for reed beds treating settled domestic wastewater. Part 1 of this Guide deals with the application and

specification of reed beds. Part 2 sets out the design and construction parameters, and maintenance requirements. It explains the role of the plants in a reed bed and describes a test for determining the suitability of sand to be used in the beds.

Traditionally, domestic wastewater has either been disposed of using a mains drainage system or cesspool, or treated by using a septic tank with an infiltration system to the soil or by using a packaged plant. However, reed bed systems are increasingly being considered for

use in various situations in the UK.

A glossary of terms is given on page 3.

More detailed guidance and background information is contained in a BRE report, Grant & Griggs: *Reed beds: application, specification, design and maintenance*.

Design and construction of a reed bed is influenced by the following factors

- I Wastewater quality and quantity
- I Required effluent quality
- I Soil type, permeability, stability, drainage and slope
- I Locally available materials such as stone or clay
- I Aesthetics/landscaping
- I Size
- I Pollution risk if leakage occurs
- I Local cost of materials and labour
- I Availability of power
- I Durability required
- I Environmental impact of materials used
- I Available skills
- I Access to site
- I Aspect of site
- I Building and planning regulations



A vertical flow system designed by Burka at Oakland Park, Gloucestershire, in its first summer of operation (Burka & Lawrence 1990). The mature system is shown on page 1 of Part 1.

© Elemental Solutions

Repairing and replacing rainwater goods

Good Repair Guide 9

good repair guide

Defective gutters and downpipes cause dampness problems in many homes. Many others have had their appearance

spoiled by inconsiderate or unsympathetic replacement of rainwater goods. This guide describes common defects

in different types of rainwater installation and gives advice on how to choose between replacement and repair.

Introduction

It is absolutely necessary to keep rain and snow melt-water out of buildings. However, BRE inspections and surveys have consistently shown that many houses have defective or inadequate gutter and downpipe installations. These defects can soon lead to dampness problems: for example, if gutters are undersized, water spillage can saturate walls and lead to dampness internally. Figures from the *English house condition survey 1991* confirm that nearly 1 in 12 of all houses have defects in their valley gutters or flashings, and 1 in 5 have defects in their rainwater disposal systems.

The rainwater systems of most existing properties were designed using traditional rules of thumb. Houses built more recently may have installations designed to BS 6367, which assumes a maximum rate for disposal purposes of 75 mm/hour where ponding and overflow cannot be tolerated. Storms of this intensity are relatively infrequent in the UK, probably occurring about once in 80 years in the wetter parts of the country (though local conditions may vary).

Most systems will overflow under extreme conditions, and it is a matter of judgement whether overflows occur on a sufficient scale to be a nuisance to the building's occupants.

When eaves and verges do not have an external gutter (eg when they are at the heads or abutments of slopes) the combination most likely to cause problems is an unguttered verge on a flat roof. There can also be difficulties with unguttered verges in exposed pitched roofs in areas of high rainfall, where strong winds blow the run-off across the roof.

BS 6367 makes provision for discharge weirs at the ends of gutters to direct overload run-off where the flows exceed the design rate. This Standard is currently being revised.



Many houses have defective gutter installations, which can soon lead to dampness problems

WATER SERVICES FOR DOMESTIC PROPERTIES

Peter Trotman* and John Griggs+

*BRE Associate, +Chartered Institute of Plumbing and Heating Engineering

This Good Building Guide covers water requirements in a domestic property. Wholesome water for consumption is normally supplied from a water main. Rainwater can be collected for use in the garden or for car washing, although if filtered and stored, can be used for WC flushing and washing machines. Greywater, collected from the property, usually from the bath, needs more treatment but can then be available for flushing WCs and garden irrigation (Figure 1).

Both cold and hot water systems are described, together with pipe sizing, components and materials. Advice is also included on reducing noise that can be generated and transmitted by water systems.

The requirement in building regulations¹⁻³ is for any property to have 'wholesome water' or softened wholesome water where drinking water is drawn off, at a washbasin in a bathroom or other location near a sanitary appliance and any sink where food is prepared. Wholesome water must comply with requirements of Regulations made under the Water Industry Act⁴.

There is an increasing requirement to reduce water use and three basic strategies can be used:

- minimise wholesome water use
- utilise rainwater
- utilise greywater.

Minimising wholesome water use

From April 2010, all new homes in England and Wales need to comply with Approved Document (AD) G of the Building Regulations¹¹, which limits total consumption to 125 litres per person per day.

Certain products can encourage economy by reducing the flow rate available. These include showers, small-size baths, water-efficient washing and dishwashing machines, flow-regulated taps, aerated taps and spray taps. There is



Figure 1: Brac⁵¹ greywater harvesting system filters water from baths, showers and laundry to be reused for flushing WCs and watering the garden

more information in *Water efficiency in new homes – an introductory guide for housebuilders*¹⁶.

Utilising rainwater

Rainwater is usually drained from roofs although it can be collected from any suitable surface around a building. At its simplest, a water butt (Figure 2) can provide sufficient water for garden irrigation and car washing. For other uses, a filter can be fitted to the downpipe and the water



bre press



bre

RAINWATER HARVESTING FOR DOMESTIC PROPERTIES

Peter Trotman* and John Griggs+

*BRE Associate, +Chartered Institute of Plumbing and Heating Engineering

This Good Building Guide covers the use of rainwater in a domestic property. Most houses have some means of collecting run-off from one or more locations including the house, garage, shed and greenhouse roofs and, possibly, paved areas. Local water suppliers have encouraged this collection of rainwater by making available, at reasonable cost, water butts together with diverters to fit in the downpipe. Systems are now available to store collected rainwater and pump it for use for irrigation and WC flushing. The different options are described together with system design, components and materials.

It will be useful to designers and building owners wanting to reduce water consumption.

Piped water within the home is a requirement of national building regulations^[1-3] and that supplied from the mains is designated 'wholesome water'. It must comply with the requirements of Regulations made under the Water Industry Act^[4].

Water usage by a household will obviously vary depending upon lifestyle, occupation pattern and the installed appliances. Average consumption per capita in the UK is between 125 and 201 litres per person per day, with the higher figure from single-person households^[5].

Most of the water used in the home is not consumed. Average figures for the European Union (EU) show that only 5% of wholesome water is used for drinking and cooking^[6]. Hence, there is a great potential to use non-wholesome water for many of the current domestic uses. For example, typical proportions of UK household water used for various purposes include:

- 35% for bathing and personal hygiene
- 26% for WC flushing
- 12% for clothes washing



Figure 1: Compact rainwater butt

- 9% for dishwashing
- 7% for outside use, eg garden watering and car washing^[7].

Although rainwater could be used for all of the above uses, the skin contact and risk of ingestion during washing and bathing would require treatment to near-wholesome water standards. However, the wastewater from bathing could be utilised for the other uses if greywater reuse was practised.



Wind, floods and climate

Water supply, drainage and sanitation

Building in winter	GG 34
Climate change	GG 63
Repairing flood damage Part 1: Immediate action	GR 11-1
Repairing flood damage Part 2: Ground floors and basements	GR 11-2
Repairing flood damage Part 3: Foundations and walls	GR 11-3
Repairing flood damage Part 4: Services, secondary elements, finishes and fittings	GR 11-4
Repairing frost damage Part 1: Roofing	GR 20-1
Repairing frost damage Part 2: Walls	GR 20-2

Building in winter

GBG 34

Winter weather often makes it difficult for builders to get on with the job. In very severe winters, sites can be at a standstill for weeks on end. Even in less severe weather, building operations are more difficult and working hours are bound to be

reduced. Frost, rain and high winds can also play havoc with newly built work unless proper precautions are taken. Some of these problems can be reduced by advance planning, good preparation of the site, care of stored materials and protection of

completed work. This Guide gives some tips and advice from BRE on how to keep interruptions to building to a minimum during winter weather, how to protect materials, and when it is vital to stop work.

Keeping the site going

A priority is making sure there is access for deliveries to the site in all weathers, including heavy trucks. If the permanent road system is not ready, there must be good temporary roads, well maintained and kept clear of snow. Make sure that any service trenches that cross

the access road are backfilled and fully compacted.

Continuous or heavy rain can play havoc with newly dug trenches, and can even result in the sides caving in. Water lying at the bottom of a trench usually means that concrete cannot be poured.



Wet conditions make it difficult to get on with the job
Photo courtesy of BDA

Climate change: impact on building design and construction

GBG 63

Over the last decade, climate change has emerged as one of the most pressing environmental issues. Concerns about its wide implications are now leading to changes in both legislation and building regulations in the UK. These have significance for all who construct, manage and own buildings. Politically and scientifically, there has been widespread debate and cynicism over the validity of predictions of climate change. In recent years, however, the argument has begun to move from 'Is it happening at all?' to 'What will it actually mean?'. There is now a growing consensus that the climate is changing at a rate unsurpassed over the last millennium and that these changes will impact on us all.

This Good Building Guide considers how the climate is changing, the potential risks this will bring to buildings and, as a consequence, how building design and construction will need to change.

The scientific understanding of climate change is growing quickly, but much more research is needed before the full implications can be known. What is understood and accepted by the majority of the scientific community is that emissions of greenhouse gases from human activities are driving the process of climate change. This has been translated politically into international activities, such as the Kyoto Protocol, that seek to start controlling global emissions of greenhouse gases. It is also generally accepted that if the production of greenhouse gas emissions is halted tomorrow, the climate would still continue to change for many years: the greenhouse gases we have released into the atmosphere over the past decades will remain there for many years. In effect there is no going back to a pre-industrial climate. Although cyclic variations are likely to continue, the control of greenhouse gas emissions is important to limit future climate change.

Buildings and the built environment are fundamental to the health, wealth and success of our society. Typically, we spend 90% of our lives

in buildings and rely on them to provide the infrastructure for us to live. One of the dangers of a changing climate is that building stock, currently performing adequately, may be compromised by future climate change, ie as conditions change existing building codes and practices become inadequate. This could have potentially disastrous consequences for those affected. Design standards therefore need to be examined to minimise future problems and to identify key risk areas in the existing building stock. There is also a need for appropriate guidance for all concerned in the construction process in order that potential risks can be understood and proactive steps taken to reduce risk.

The aim of this *Good Building Guide* is to provide advice and guidance for making a pragmatic and proactive assessment of the opportunities and threats afforded by climate change. It aims to highlight practical first steps for reducing future risks and thereby producing a robust future proof building.

Figure 1 Will a changing climate alter our perspective of traditional construction?



Repairing flood damage: immediate action

Good Repair Guide 11

Part 1

This Guide is the first in a series dealing with repairs to damage caused by flooding. External flooding may immerse parts of a building for several days, but even a few hours can lead to drying times of several weeks.

This guide gives advice on cleaning the building during the first few days after the flood water has receded: such action can reduce the reoccupation time and minimise repairs and replacement. Much of the advice applies also to

damage caused by burst pipes, leaks and storm damage. This guide will help building owners and occupiers but will also assist surveyors, contractors and insurers.

Other parts to this Guide

For repairs to ground floors and basements – see Part 2

For repairs to foundations and walls – see Part 3

For repairs to services, secondary elements, finishes, fittings – see Part 4

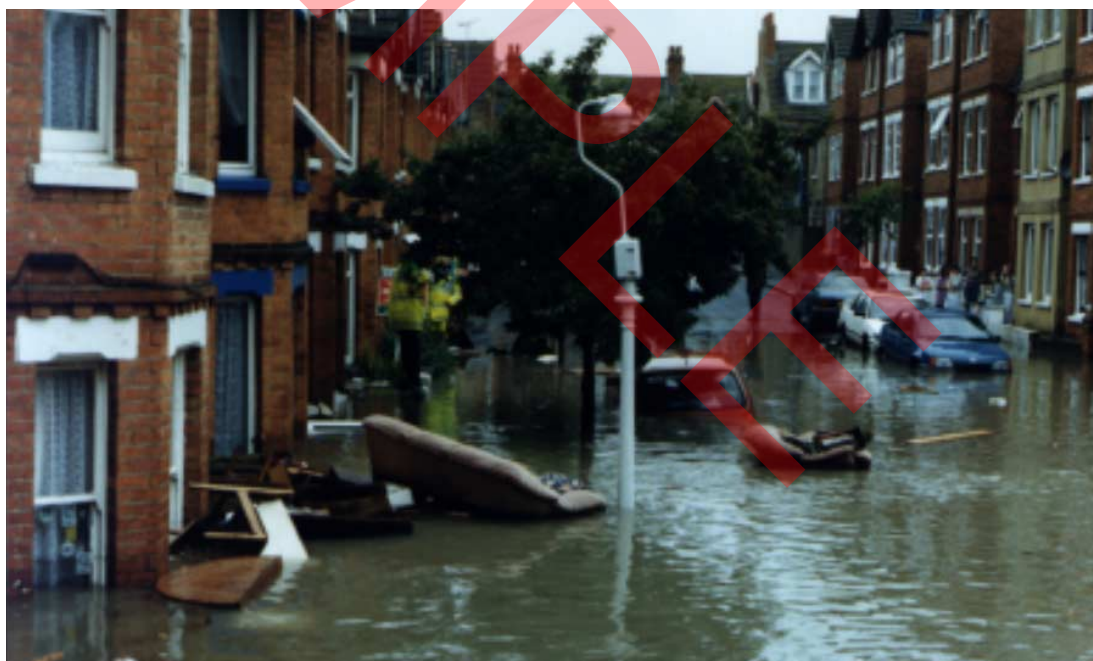

Courtesy of Max Hess, Folkestone, Kent

Immediate action

- | Check for external structural damage
- | Switch off electricity supply
- | Shut off gas appliances
- | Check drainage system
- | Contact insurers
- | Remove wet carpets and furniture
- | Clean walls and floors
- | Drain floors and cavities
- | Start drying the building

Repairing flood damage:

ground floors and basements

Good Repair Guide 11

Part 2

good repair guide

This Guide gives advice on the treatment and repair of floors, and the draining of underfloor areas and basements. The type of floor is significant as flooding affects floor constructions in different ways. This advice covers

both older and new types of floors: suspended timber, concrete on the ground and suspended concrete (including those containing insulation). Information on drying, ventilation, measuring moisture contents, and

reinstatement of flooring, is dealt with in conjunction with the appropriate floors. This guide will help surveyors, contractors and insurers to advise building owners and occupiers.

Other parts to this Guide

For immediate action after flooding – see Part 1

For repairs to foundations and walls – see Part 3

For repairs to services, secondary elements, finishes, fittings – see Part 4



Courtesy of W A Fairhurst & Partners, Dundee (left); Max Hess, Folkestone, Kent (right)

Priorities

- | Inform the insurers, if this has not already been done (see Part 1)
- | Start drying the building with ventilation and heating
- | Expose the floor surface and determine the type of floor construction
- | Investigate the construction and condition of the floor
- | Determine any repairs needed and obtain estimates of the cost
- | Drain under any suspended floors and any basement areas

Repairing flood damage: foundations and walls

Good Repair Guide 11

Part 3

good repair guide

This Guide gives advice on the treatment and repair of foundations and walls which have been affected by flooding. The type of wall will be significant as water affects wall materials in different ways.

This advice is given for wall constructions in general use: solid walls, cavity walls, timber-frame walls and non-traditional walls. Information on different wall finishes: plaster on lathing, plaster on masonry

and plasterboard, are dealt with in conjunction with the appropriate wall types. This guide will help surveyors, contractors and insurers to advise building owners and occupiers.

Other parts to this Guide

For immediate action after flooding – see Part 1

For repairs to ground floors and basements – see Part 2

For repairs to services, secondary elements, finishes, fittings – see Part 4



Courtesy of Max Hess, Folkestone, Kent (left); W A Fairhurst & Partners, Dundee (right)

Priorities

- | Inform the insurers, if this has not already been done (see Part 1)
- | Stabilise the foundations
- | Start drying the building with ventilation and heating
- | Investigate the construction and condition of the walls
- | Decide on repairs and obtain estimates of costs
- | Remove wet materials and surface coatings that may delay drying

Repairing flood damage:

services, secondary elements, finishes, fittings

Good Repair Guide 11

Part 4

good repair guide

This Guide gives advice on the equipment, internal partitions, doors, windows and fittings such as kitchen units in a building damaged by flood. It deals with the

period after the initial cleaning: inspection, drying and repair of each item. Priorities are included to achieve early occupancy of

the building. This guide will help surveyors, contractors and insurers to advise building owners and occupiers.

Other parts to this Guide

- For immediate action after flooding – see Part 1
- For repairs to ground floors and basements – see Part 2
- For repairs to foundations and walls – see Part 3



Courtesy of W A Fairhurst & Partners, Dundee

Priorities

- | Inform the insurers, if this has not already been done (see Part 1)
- | Repair the electricity and gas systems
- | Run the heating system or install portable heaters
- | Investigate the condition of equipment, partition walls, doors, windows, and fittings
- | Decide on repairs needed and contact insurers
- | Occupy the building if possible

Repairing frost damage: roofing

Good Repair Guide 20

Part 1

good repair guide

Some materials are damaged by a combination of low temperatures and high moisture contents. Cycles of wetting and freezing are more damaging than prolonged cold-dry conditions. Roof

coverings can be damaged by 'ground' frosts. Specification, quality control and the level of building maintenance can influence performance. This Good Repair Guide gives advice on diagnosing

frost damage, its likely course, and methods of repair. Advice is given on the choice of whether to replace or repair, to help surveyors and contractors decide on appropriate action.

Further practical guidance

For repairing frost damage to walls – see Part 2 of this Guide

For re-covering pitched roofs – see Good Repair Guide 14

For repairing chimneys and parapets – see Good Repair Guide 15



Old roof with frost-damaged tiles needing extensive repair or re-covering



Different strategies for 30-year-old houses. Left, roof re-covered with concrete tiles. Right, frost-damaged clay tiles replaced

Some important questions to answer

Diagnosis

- | Is the damage caused by frost, salt crystallisation, or mechanical impact?

Causes

- | Are there design, material, component manufacture, workmanship or maintenance deficiencies?

Course of deterioration

- | Will damage continue, stabilise, or accelerate?

Repair

- | Will repairs be permanent, unobtrusive, acceptable to planning authorities, need reclaimed components, and include widespread replacement?

Repairing frost damage: walls

Good Repair Guide 20 Part 2

good repair guide

Some materials are damaged by a combination of low temperatures and high moisture contents. Cycles of wind-driven rain and freezing are more damaging than prolonged cold-dry conditions. Climate, constructional

features, location in the building, frost susceptibility and quality control can all influence the risk of frost damage. This guide gives advice on diagnosing frost damage, its likely course, and methods of repair.

Advice is given on the choice of whether to repair or replace, to help surveyors and contractors decide on appropriate action. Water repellents for reducing damage are briefly discussed.

Further practical guidance

For repairing frost damage to roofing – see Part 1 of this Guide



Frost damage to clay brick wall about 25 years old



Further frost damage to 28-year-old concrete brick wall following repairs to the frost-damaged coping and end, about 10 years after being built

Some important questions to answer

Diagnosis

- | Is the damage caused by frost, sulfate attack, salt crystallisation, corrosion of wall ties, or foundation movement?

Causes

- | Are there design, component, workmanship or maintenance deficiencies?

Course of deterioration

- | Will damage continue, stabilise, or accelerate?

Repair

- | Will repairs be permanent, unobtrusive, acceptable to planning authorities, need reclaimed components, and include widespread replacement?

Fire safety, security and crime prevention

Fire safety, security and crime prevention

Installing fire-resisting ductwork and dampers

GG 81

SAMPLE

INSTALLING FIRE-RESISTING DUCTWORK AND DAMPERS

Norman Macdonald and Ian Stewart

This Good Building Guide is designed to illustrate the importance of correctly installing fire-resisting ductwork and dampers to ensure the safety of building occupants and the protection of property in the event of a fire. Some key fundamentals for the guidance of specifiers, manufacturers, contractors and approval authorities are given, together with useful references to more comprehensive documents. The importance of adequate testing, product quality, installation, maintenance and the critical role of third-party certification schemes are highlighted.

In the year ending 31 March 2009, there were approximately 75,000 fires in buildings in the UK, resulting in some 350 lives lost and about 10,000 non-fatal injuries. The annual cost to the UK of fires in buildings is several billion pounds in lost property and business. Therefore, it is vital to keep our buildings as fire safe as possible.

A critical weakness in the fire safety of any building can be the penetration of fire compartment walls and floors by building services such as cables, pipes and ductwork, including dampers. Potential fire spread via a ductwork system is of particular concern as it is designed to distribute air throughout the building. A fire attacking such a system that is not designed and installed properly has the potential to spread fire, smoke and toxic gases rapidly to more than one compartment within the building with consequences for life safety and property protection.

This guide highlights the importance of correct installation of ducts and dampers in buildings and focuses on some of the key points and issues. The guide assumes that the overall design and function of the complete ductwork and damper system, including any associated

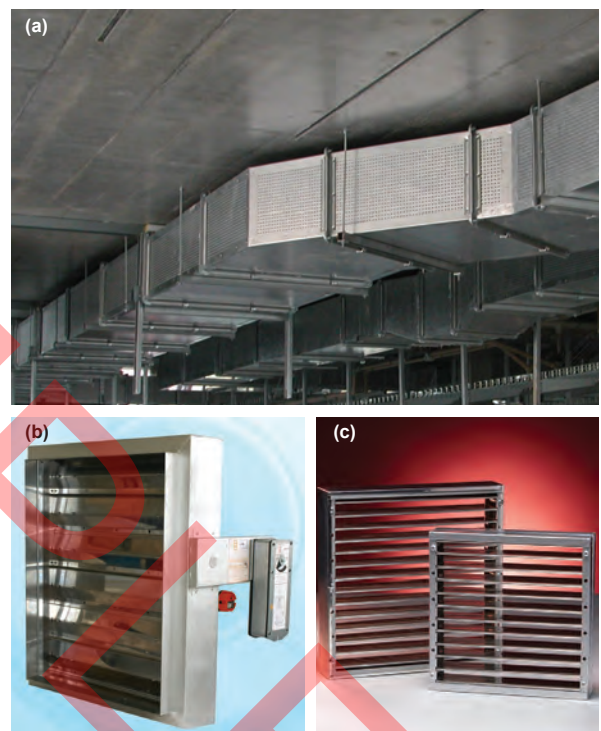

Figure 1: (a) Fire-resisting duct system, (b) steel fire damper, (c) intumescent fire damper

active fire protection systems such as smoke detectors, have been designed following the relevant codes, guides and standards.

When discussing dampers, the guidance in this document has focused on steel dampers. It may be that an intumescent damper is also suitable for certain situations. In this case, some of the guidance may not be appropriate.



bre press

bre global

Composites, fibre reinforced materials and metals

Composites, fibre reinforced materials and metals

Repair and maintenance of FRP structures

GR 34

SAMPLE

Sue Halliwell and Ed Suttie

BRE Construction Division

This Good Repair Guide sets out recommendations for the routine inspection and management of FRP structures. Details of repair techniques are also given together with their limitations.

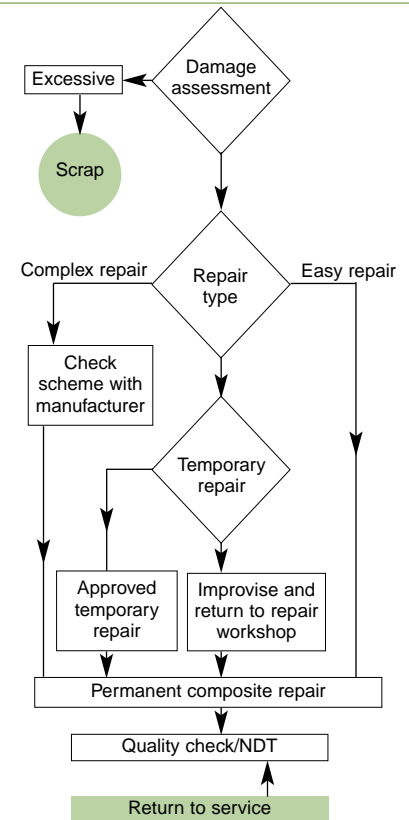

Figure 1 Flow chart for composite repair. © Hexcel

Fibre-reinforced polymers (FRPs) exhibit excellent performance in service. However, as with any construction material, they can be subject to damage. This damage may be intentional or unintentional. Intentional damage can occur when the FRP components or structures are cut or drilled during installation. Unintentional damage can be caused by:

- accidental impact,
- unexpected excessive loading, or
- long-term environmental exposure.

Any damage or alteration to the fibres and/or the resin may alter the performance properties of the FRP component.

Routine maintenance of structures

A well designed and fabricated FRP system will not require much in the way of routine maintenance. However, routinely maintaining a FRP structure can significantly improve its long-term performance. The maintenance procedures listed in Box 1 will prolong the service life.

Box 1 Maintaining FRP structures

- Keep all gutters, drains, etc. clear of debris so that rainwater is carried off the structure.
- Check cleaning solvents to ensure they will not damage the FRP as some may not cause obvious immediate problems, but may soak into the FRP and lead to long-term deterioration. Water or a mild detergent solution with a soft cloth is adequate for most cleaning purposes.
- Remove graffiti by surface cleaning. Don't use water jetting or grit blasting as they are likely to cause damage.

Inspection of structures

Buildings rarely undergo routine inspections. Often, inspections are only carried out when there is a change of ownership. To ensure prolonged life, building owners should instigate a regular inspection regime for FRP structures and those containing FRP components (see Table 1 and Box 2). Details of the inspection should be included in the Health & Safety file. This file should indicate the key locations to be inspected.

Mortar, render and plaster

Mortar, render and plaster

Assessing external rendering for replacement or repair	GG 23
Building masonry with lime-based bedding mortars	GG 66
Choosing external rendering	GG 18
Plasterboard: Part 1. Types and their applications	GG 70-1
Plasterboard: Part 2. Fixing and finishing non-separating walls and floors	GG 70-2
Plasterboard: Part 3. Fixing and finishing separating and compartment walls and floors	GG 70-3
Plastering and internal rendering: Design and specification	GG 65-1
Plastering and internal rendering: Workmanship	GG 65-2
Repairing external rendering	GG 24
Replacing failed plaster	GG 7
Replacing plasterwork	GR 18

Assessing external rendering for replacement or repair

Renders applied to external walls can last for many years. However, the need for maintenance and repairs may arise from neglect or damage, from the use of unsuitable

materials or treatments, or from poor workmanship. This guide is for building surveyors, contractors and site supervisors. It gives advice on the systematic inspection of

failed external rendering and the underlying structures, and guidance on whether to repair or replace.



A rendered wall in poor condition. The rendering is discoloured and cracked and has become detached.

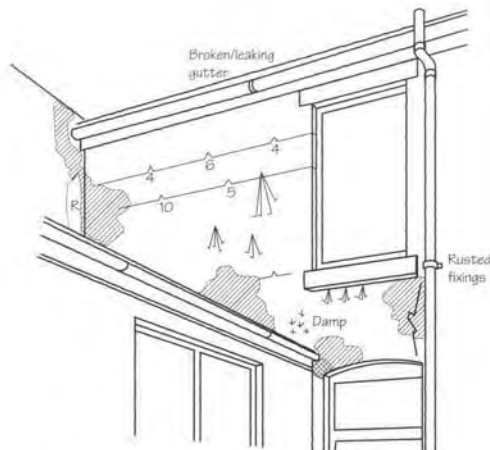

Sketch of the failed rendering shown in the photograph above (see next page for symbols).

Building masonry with lime-based bedding mortars

GBG 66

Bob de Vekey

BRE Construction Division

Until about 1840 when ordinary Portland cement (OPC) was developed, lime was used in mortars for all kinds of building. It is now enjoying a revival and is being promoted by conservation organisations for restoration work and by environmentalists as an environmentally friendly material. Some of the benefits of lime mortars are that they allow walls to breathe, are relatively flexible (accommodating some movement), give some protection to surrounding brick and stone against salt and frost damage, 'self-heal' when exposed to air, and allow brick and stone to be reclaimed after demolition.

Lime mortar can be used for new build as well as for restoration and conservation work. This Good Building Guide gives guidance on the properties of lime mortars, mortar mix design and working with lime mortars. However, practice varies within the British Isles and the reader is advised to make sure that proposed works comply with local specifications, especially for heritage buildings. Some helpful further reading is given on page 8.

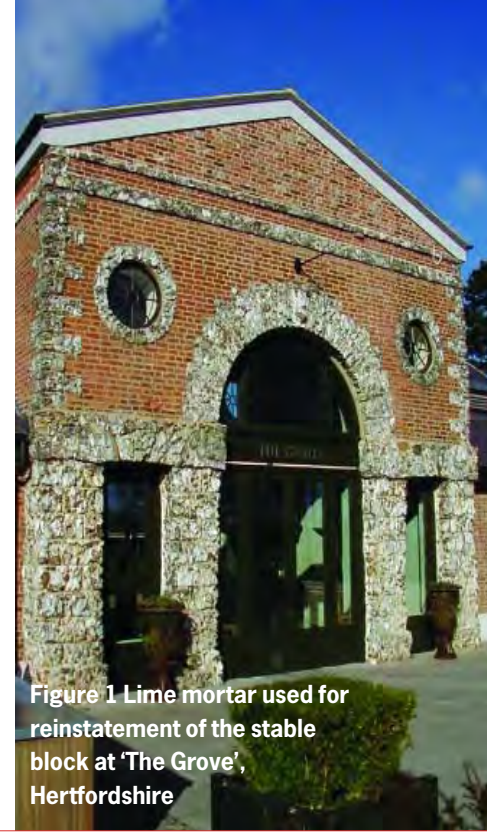

Figure 1 Lime mortar used for reinstatement of the stable block at 'The Grove', Hertfordshire

Mortar has been used for thousands of years as a packing material to allow stable walls and other structures to be built from irregularly shaped pieces of stone and brick (Figure 1). Its essential characteristics are listed in Box 1.

Generally, mortar comprises a mixture of:

- an inert aggregate (ie fine sand or sandy soil),
- a chemically active binder which glues the mixture together, and
- water which gives the initial plasticity.

As a general rule, the optimum ratio of fine binder/filler to aggregate is between 1 to 2 and 1 to 3.

A wide range of materials has been used for such applications, ranging from river mud, which is suitable for drier climates or where protected from moisture, to contemporary hydraulic cement-based mortars. Lime-based mortars, which probably date back to the biblical era and the Roman empire, consist of a mixture of lime (calcium hydroxide), sand, water and, optionally, pozzolanic compounds and fillers. Early classic books on the technology of mortar are those of Vicat^[1] and Cowper^[2].

Box 1 Essential characteristics of building mortar

- It should have sufficient working life (pot life) to minimise wastage due to premature set. When mixing mortar ensure that whole economically sized batches are made that can be consumed before setting.
- It should flow freely when worked but have sufficient cohesiveness (viscosity) to prevent drainage and 'runs' which cause unsightly stains.
- It should stiffen 'set' in contact with absorbent solid masonry units.
- It should ideally assist the finished wall to breathe, ie allow moisture vapour to escape via the pore system.
- It should gain sufficient strength and bond in the short term to enable the masonry to bear the weight of superimposed masonry and floors without damage.
- It should gain sufficient strength and bond in the long term to distribute occupancy loads evenly and to resist wind and other mechanical forces while not exceeding the strength of the units.
- It should chemically harden sufficiently to make it durable in the face of rain, water containing soluble salts, acids, frost attack and wind.
- It should seal the masonry to inhibit free flow (percolation) of liquid water and air from one face to the other (usually external to internal spaces).
- It should result in a pleasing finish to the masonry.

Choosing external rendering

CI/SfB P q (41) (A3)
CAWS M20

Rendering has a long history of use on various types of external walls, usually to improve weathertightness but also for aesthetic reasons. For buildings up to four storeys, this guide gives outline advice to assist specifiers and builders in choosing render for different backgrounds and exposure, and includes summary guidance on materials selection and surface preparation. Although intended for use on new construction, the advice is broadly

relevant to existing buildings where render has not been used previously or where old render is to be completely replaced, but only if walls are sound and free of damp. With historic buildings it is recommended that specialist advice is obtained before starting.

Careful detailing (see below) and good workmanship are essential if render is to give a good service life.

Importance of good detailing

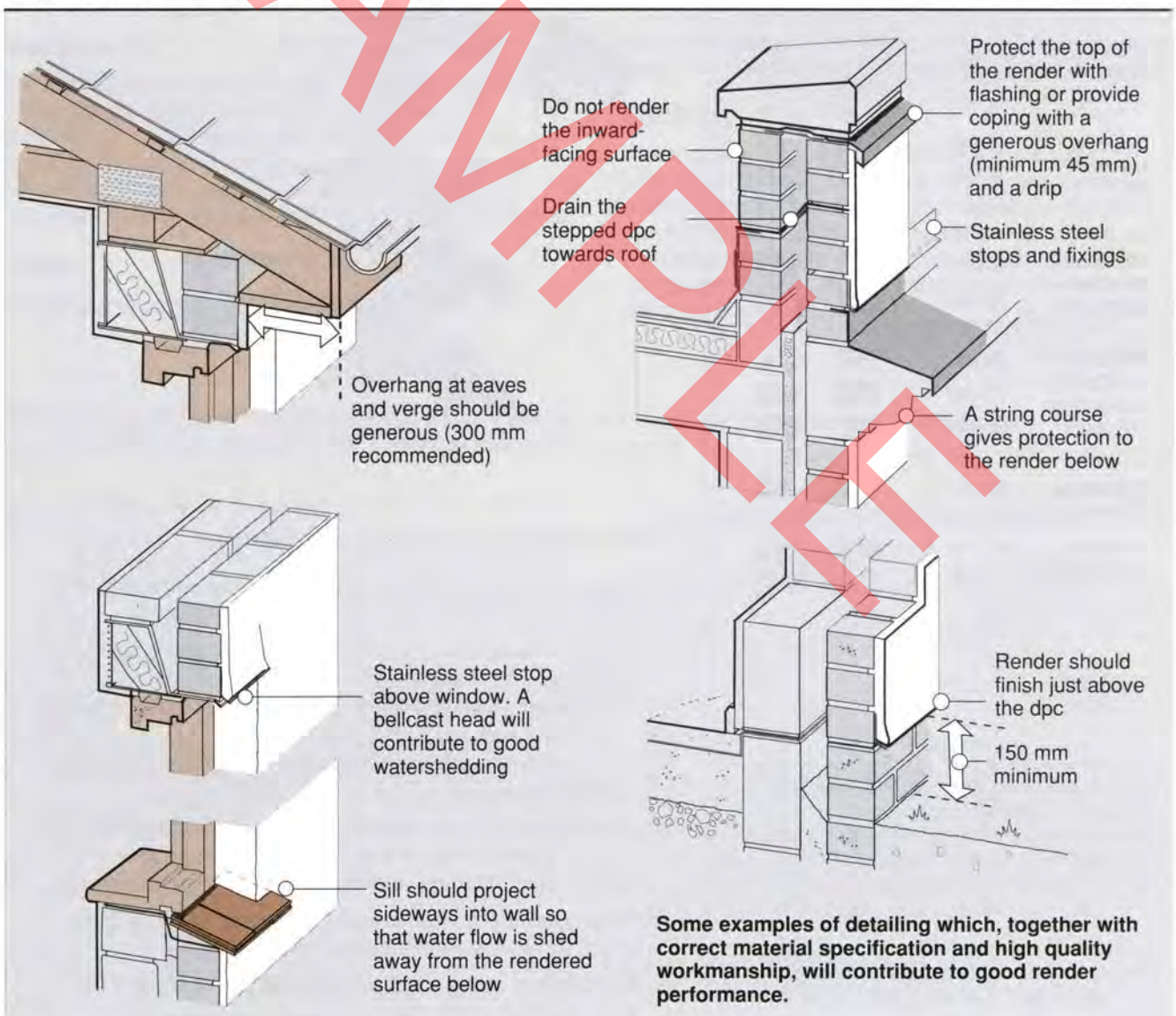

Plasterboard: Types and their applications

GBG 70 Part 1

Plasterboard offers solutions to the requirements of recent revisions to Approved Documents L and E of the Building Regulations (England & Wales). Many builders will use some form of plasterboard system. The percentage of wallboard used in all forms of building is increasing, and is likely to continue to increase. From 1 October 2006 plasterboard sold in the UK may have CE marking and from 1 March 2007 plasterboard cannot be sold in the EU without CE marking.

Standard wallboard provides a low cost internal lining board appropriate for most environments, offering a surface suitable for decoration and providing a degree of sound, fire and impact resistance. There are specially formulated boards for specific performance requirements. This Good Building Guide describes the range of boards available and when they can be used.

Parts 2 and 3 provide practical guidance on fixing and finishing plasterboard.



Types of plasterboard

Plasterboard is typically an inner layer of gypsum sandwiched between two outer layers of lining paper. Various additives can be added to the gypsum layer, and the weight and strength of the lining paper can be varied to give different properties to the finished board.

Fire-resistant grade boards are used extensively for fire protection and are rated by the time it takes for the board to fail during a fire-resistance test. Some multilayer applications can achieve up to a 4-hour resistance rating when tested against an appropriate fire-resistance test standard.

Plasterboard contributes to reduction of sound transmission, particularly airborne sounds such as speech and music. High performance sound insulation board has a denser core that provides improved insulation against sound.

While standard plasterboard is ideal for most environments, it shouldn't be used in constantly damp conditions. For kitchens, bathrooms and similar high humidity environments, moisture-

resistant board should be used. These boards are specially designed with moisture additives in the core so that they repel water. They are good as wall tile backers.

Most common plasterboards come with the option of either a tapered edge or square edge. Tapered edge boards are ideal for either jointing or skimming, while a square edge is generally used for textured finishes.

Plasterboard generally comes in 1200 mm wide sheets, designed to suit the standard 600 mm stud spacing. Other widths are available, for instance 900 mm widths commonly used in metal stud partition systems. These boards have manual handling advantages over the 1200 mm wide boards as the board weight is reduced and the board is easier to handle within confined areas.

Most standard plasterboard has one ivory face and one grey face. The liner on the ivory face is designed for plastering; plaster should not be applied to the grey face. Paper liners are generally made from recycled paper: a big plus for the environment.



Plasterboard:

Fixing and finishing non-separating walls and floors

GBG 70

Part 2

Harry Harrison

Plasterboard is widely used in the construction industry since it offers a low cost internal lining board suitable for many environments, and for decades has found particular application in the housing field.

To achieve satisfactory performance of the completed construction, it is crucial that the correct type, thickness or mass of plasterboard is selected (see Part 1). It is equally crucial that the appropriate fixing and finishing techniques for each type of board are employed on site.

Parts 2 and 3 of this Good Building Guide draw from BRE observations of site practices and will provide operatives with a summary of fixing and finishing techniques that are often carried out to an inadequate standard, together with checklists for use at both design and site stages. It is not in itself a comprehensive manual on fixing and finishing, and should therefore be used in conjunction with manufacturer's guidance.

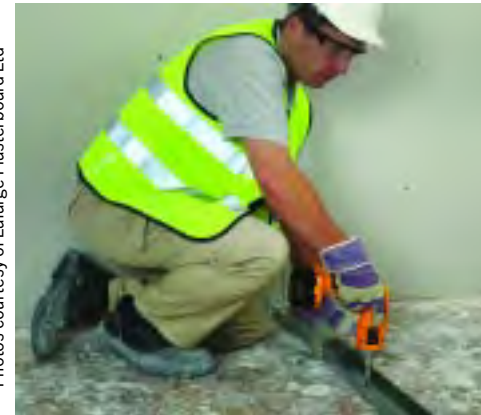

Photos courtesy of Lafarge Plasterboard Ltd

Part 2 covers general points on fixing and finishing of plasterboard, using illustrations for walls and floors which do not have any separating or compartmenting function, that is to say mainly those in detached houses and bungalows and ceilings in terraced housing. Plasterboard used in separating and compartmenting walls and floors is covered in Part 3. This *Good Building Guide* does not cover prefabricated plasterboard partitions, covings, nor casings to structural steel to afford fire protection. For these, the manufacturer should be consulted.

Site storage of boards

Boards should be stacked flat on 100 mm wide battens the full width of the sheets, positioned at less than 400 mm centres on a level surface in the dry. Do not overload large span suspended timber floors: a stack of more than approximately 15 × 15 mm boards could exceed the allowable imposed loading on many domestic floors. Boards should be carried on edge; they should never be stacked on edge.

Box 1 Types of plasterboard (see also Part 1)

Make sure that you have the correct type of plasterboard specified for its intended position. Check the manufacturers' trade names and use of colour coding.

- Standard wallboard 12.5 and 15 mm thick for dry-lining and general use. Although 9.5 mm board may still be available, its use is normally limited to situations where there are no fire and sound insulation criteria
- 10 kg/m² wallboard to meet specific building regulation requirements
- 19 mm plank: a thicker but smaller board that is easier to handle than standard wallboard
- Sound insulation board 12.5 and 15 mm thick with modified cores, coloured blue
- Impact-resistant board with glassfibre reinforced cores
- Moisture-resistant board with modified cores and water-repellent liners, coloured green or blue
- Fire-resistant board 12.5 and 15 mm thick with modified cores, coloured pink
- Thermal board with various kinds of sheet insulation in various thicknesses laminated to the board
- Vapour control layer plasterboard, with the vcl laminated to the board

Plasterboard:

Fixing and finishing separating and compartmenting walls and floors

GBG 70

Part 3

Harry Harrison

Plasterboard is widely used in the construction industry since it offers a low cost internal lining board suitable for many environments, and for decades has found particular application in the housing field.

To achieve satisfactory performance of the completed construction, it is crucial that the correct type, thickness or mass of plasterboard is selected (see Part 1). It is equally crucial that the appropriate fixing and finishing techniques for each type of board are employed on site.

Parts 2 and 3 of this Good Building Guide draw from BRE observations of site practices and will provide operatives with a summary of fixing and finishing techniques that are often carried out to an inadequate standard, together with checklists for use at both design and site stages. It is not in itself a comprehensive manual on fixing and finishing, and should therefore be used in conjunction with manufacturer's guidance.



Photos courtesy of Lafarge Plasterboard Ltd

Part 3 of the *Good Building Guide* covers fixing or incorporation of plasterboard to walls and floors which have a separating or compartmenting function, that is to say mainly in terrace houses and flats and in other building types where the use of plasterboard is appropriate. For site storage of boards, for plasterboard used on other walls and floors and for finishing surfaces, see *Part 2*.

The illustrations in this *Part* are based on the requirements of the England & Wales Building Regulations. Similar requirements will be found in the Scotland and Northern Ireland Building Regulations.

Separating floors

Separating floors must be used with the appropriate flanking structure to achieve the required level of acoustic performance.

Three types of separating floor are described in the England & Wales Building Regulations (Figure 1).

Box 1 Types of plasterboard (see also Part 1)

Make sure that you have the correct type of plasterboard specified for its intended position. Check the manufacturers' trade names and use of colour coding.

- Standard wallboard 12.5 and 15 mm thick for dry-lining and general use. Although 9.5 mm board may still be available, its use is normally limited to situations where there are no fire and sound insulation criteria
- 10 kg/m² wallboard to meet specific building regulation requirements
- 19 mm plank: a thicker but smaller board that is easier to handle than standard wallboard
- Sound insulation board 12.5 and 15 mm thick with modified cores, coloured blue
- Impact-resistant board with glassfibre reinforced cores
- Moisture-resistant board with modified cores and water-repellent liners, coloured green or blue
- Fire-resistant board 12.5 and 15 mm thick with modified cores, coloured pink
- Thermal board with various kinds of sheet insulation in various thicknesses laminated to the board
- Vapour control layer plasterboard, with the vcl laminated to the board

Plastering and internal rendering: Design and specification

GBG 65 Part 1

Harry Harrison

The acceptability of the wall and ceiling plastered finish can be a significant item in the snagging procedure. Selection of appropriate materials and techniques may not always be thorough, particularly with respect to shrinkage of backing coats and resultant cracking, and detachment of surfaces. Rigorous design procedures and quality control on site are therefore of major importance in reducing, if not eliminating, defects. This Good Building Guide addresses these issues, drawing primarily from the experience of BRE site investigations.

Part 1 describes the commonest types of gypsum and cement-based plasters available, the selection of suitable plastering specifications, whether for skim coat, two-coat or three-coat work in relation to the substrate material of wall or ceiling, the protection of abutments, avoidance of potential loss of adhesion, and thermal and moisture movements of the most common backgrounds and plasters.

Workmanship, including permissible deviations of the finished surfaces, is dealt with in Part 2.



Figure 1 Application of the base coat of render. Note the beads in situ around the window opening

Plastering is one of the few manual processes remaining in construction that is not amenable to completion or partial completion off site, though a degree of in-situ mechanisation may be possible for projection plasters. In spite of the greater use of filled joint board finishes, wet plastering remains a popular technique as long as relevant skills are available.

At the time of publication of this *Good Building Guide*, standards relating to plasters and renders are under revision. Although BS 5492:1990: *Code of practice for internal plastering*, has been partially replaced, the new British and European Standards BS prEN 13279-1 *Gypsum and gypsum-based building plaster. Part 1. Definitions and requirements* which will replace BS 1191-1, and BS prEN 13914-2 *Design, preparation and application of external rendering and internal plastering. Part 2. Internal plastering*, together with a national annex, which will replace the remainder of BS 5492, have yet to be published.

About this Good Building Guide

This Good Building Guide deals exclusively with plastering on new construction. However, some of the techniques described in Good Building Guide 7 on 'Replacing failed plasterwork' (eg matching the system to the background) also apply to this Good Building Guide, and the gist of those recommendations is therefore repeated here.

This Good Building Guide does not deal with:

- plasterboard fixing and finishing,
- gypsum mortars, or
- plastering techniques appropriate to the restoration of heritage buildings, including:
 - the use of exclusively lime-based formulations,
 - scaglioli work,
 - the addition of animal hair as reinforcement,
 - plastering on laths,
 - the running of cornices in wet plaster using wood or metal profiles, and
 - the casting of decorative plaques in fibrous plaster or other surface modelling such as pargetting.

Plastering and internal rendering: Workmanship

GBG 65 Part 2

Harry Harrison

The acceptability of the wall and ceiling plastered finish can be a significant item in the snagging procedure. Selection of appropriate materials and techniques may not always be thorough, particularly with respect to shrinkage of backing coats and resultant cracking, and detachment of surfaces. Rigorous design procedures and quality control on site are therefore of major importance in reducing, if not eliminating, defects. This Good Building Guide addresses these issues, drawing primarily from the experience of BRE site investigations.

Part 1 describes the commonest types of gypsum and cement-based plasters available and the selection of suitable plastering specifications. Part 2 covers good practice, dealing with storage and handling of materials, protection of surrounding construction, preparation of surfaces, control of suction, dubbing out, bonding agents, permissible deviations, check lists and restoration of defective work.



Figure 1 The scratch coat has been completed, and the detritus is being cleaned off the batten

Good practice

Storage and handling of materials

Particular attention should be paid to storage conditions and shelf life. Trade names alone are not sufficient to distinguish different kinds of plasters, and great care must be taken to identify correctly different plasters when taken from site storage.

Bagged gypsum, lime and cement should be separately stored in a weatherproof building. They should be off the ground and not more than eight bags high. The bags should be used in the order of delivery, making sure that shelf life has not expired. Portland cement and lime may cause skin irritation so protective clothing should be worn.

Restrictions due to weather conditions

Plastering should not take place on frozen surfaces and is not advisable at ambient temperatures of 5 °C or less. In unheated buildings in winter conditions, care should be taken to protect the newly plastered wall from frost.

About this Good Building Guide

This Good Building Guide deals exclusively with plastering on new construction. However, some of the techniques described in Good Building Guide 7 on 'Replacing failed plasterwork' (eg matching the system to the background) also apply to this Good Building Guide, and the gist of those recommendations is therefore repeated here.

This Good Building Guide does not deal with:

- plasterboard fixing and finishing,
- gypsum mortars, or
- plastering techniques appropriate to the restoration of heritage buildings, including:
 - the use of exclusively lime-based formulations,
 - scaglioli work,
 - the addition of animal hair as reinforcement,
 - plastering on laths,
 - the running of cornices in wet plaster using wood or metal profiles, and
 - the casting of decorative plaques in fibrous plaster or other surface modelling such as pargetting.

Repairing external rendering

GBG 24

Renders applied to external walls can last for many years.

However, the need for maintenance and repairs may arise from neglect or

damage, from the use of unsuitable materials or treatments, or from poor workmanship.

This guide is for building surveyors, contractors and

site supervisors.

It gives advice on the possible causes of failure, and suggests what remedial action to take.

Use *Good Building Guide 23* for advice on the systematic inspection of failed external rendering and the underlying structures, and for guidance on whether to repair or replace.

Use *this* guide to identify the defects and to help you decide on the appropriate repair, and *Good Building Guide 18* for choosing the render.

Always seek specialist advice before undertaking restoration or repair to old renders on historic or conservation buildings or where lime bound renders have been used.

Specialist advice also must be sought for repairs to renders over thermal insulation, for the removal of graffiti, and for painted renders.



Vertical cracking of external rendering which probably could be repaired

Replacing failed plasterwork

In rehabilitation work, the replacement of internal plaster is a common and often expensive operation. Complete replastering may be necessary, particularly where the positions of internal partitions are to be changed or where old deteriorated lime plaster is present. If only localised failure caused by dampness or movement has occurred, partial replacement or repair will sometimes be possible.

This Guide, for supervisors on site, shows how to prepare commonly encountered background surfaces for wet plastering and internal render, and how to select appropriate plaster systems to achieve a sound, durable finish. It also includes summary advice on how replacement plasters might contribute to overall building performance. A separate future guide will cover the installation of dry linings.

Contents

- Introduction page 2
- Practical considerations pages 3 to 5
- Pre-plastering checklist page 5
- Matching the plaster system to the background pages 6 to 7

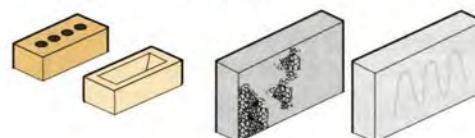

- Finishing page 8
- Further information page 8



Careful preparation and choice of plaster will ensure good performance on this mixed background surface

Replacing plasterwork

Good Repair Guide 18

good repair guide

Replacement of old or damaged internal plasterwork is an expensive business. It can be more complicated than new work because the plaster often has to be applied to a mix of backgrounds which may

sometimes be damaged or contaminated. It is one of the few parts of the job where the quality is obvious to the client — if the plasterwork is poor, he is likely to question the workmanship of the parts he can't see.

This Good Repair Guide gives guidance on common reasons for failure in plasterwork, how to prepare different background surfaces for wet replastering, and how to select a suitable plaster system.

For localised defects, it may be possible to repair only the affected sections but most of the factors affecting complete replastering will still have to be taken into account.

Why did it fail?

Before embarking on any replastering, it is important to find out why the existing plaster failed. Unless the underlying causes are remedied, most plaster defects will occur again after repair.

It is a common mistake to blame plaster failures on the wrong choice of materials or poor workmanship. Although they are both important factors, they are not the only causes of problems: defects such as cracking or efflorescence are likely to be due solely to the background. Some common failures and their causes are discussed in the following sections.

Detachment from the background

When the bond between the background and the undercoat is poor, differential thermal or moisture movement of the background can soon lead to detachment of the plaster. This can result in hollow patches, flaking, blistering or curling. Poor bond can occur when:

- l the background surface has not been prepared to give an adequate key,



If plaster is damaged by dampness or cracking, it is vital to find out the cause before replastering

- l the surface is powdery or spalling,
- l there is inadequate control of a very porous (high suction) background,
- l the background surface has not been sealed adequately to prevent plaster drying out before it has set,
- l there is poor suction due to high moisture content in the background.

Paints, adhesives and sealants

Paints, adhesives and sealants

Internal painting: tips and hints

GR 19

Maintaining exterior wood finishes

GG 22

Refixing ceramic wall tiles to internal walls

GR 29

SAMPLE

Internal painting: tips and hints

Good Repair Guide 19

good repair guide

Internal decoration is generally quite straightforward and it is less likely to cause problems than outside painting. Modern paints offer a wide choice of finishes and the techniques needed to get a good finish are well known.

But there can be snags: you can, for instance, be faced with painting on damp or unsound plaster or dealing with persistent mould growth on walls. Sometimes there are health hazards involved in removing old finishes or applying solvent-borne

paints indoors. This Good Repair Guide gives advice from BRE on how to tackle some of the problems that crop up during internal painting, where to use fungicidal paints, and when to take safety precautions.

Painting new plaster

The critical factor in achieving a good painted finish on new plaster is whether the plaster has dried sufficiently. Excessive moisture can make it difficult to apply most types of paint and may also affect long-term performance.

If possible, give new plaster time to dry thoroughly before decorating, otherwise efflorescence (see overleaf) can damage the finish as the plaster dries. If the finish is impermeable, water in the new plaster may make the finish flake away from the plaster.

The drying time for new plaster varies, depending on its area and moisture content, on whether the building fabric was dry when it was done, the time of year and the level of heating. It can take as long as 12 months.

Always aim for slow drying out, to avoid cracks in masonry materials and warping of timber components. But, if necessary, drying can be speeded up: good ventilation is essential, and there must also be heating. Don't use portable oil or gas heaters as they produce a lot of moisture. Dehumidifiers are helpful, providing there is adequate heating, but they must not be run with external ventilation.

To find out whether new plaster is dry enough for permanent decoration, it is wise to measure the moisture content. There are



It is important to dilute the first coat of emulsion paint on new plaster to avoid the risk of disastrous peeling or flaking

several possible ways of doing this, including a hygrometer and electrical moisture meters. All of them need care in interpreting the readings.

Obviously it may not be practicable to wait for the plaster to dry out fully. To decorate damp plaster the only safe finish is 'contract' or 'trade matt' emulsion paint, and even these may not cope with really wet conditions.

Make sure the occupants know when permanent non-permeable decorations such as vinyl emulsion paint or wallpaper can safely be applied: usually after 12 months.

Maintaining exterior wood finishes

To make a good job of exterior redecoration of timber windows and doors you must choose the right finish and prepare the surface thoroughly.

In recent years a number of new water and solvent-borne paints have been marketed specifically for exterior joinery, and the range of exterior wood stains, popular for new housing, is increasing. The wide range of technologies used in their manufacture (some of which are unique) can make the choice difficult.

This guide gives advice on which type of finish to specify for external timber doors and windows. It looks at the advantages and disadvantages of each and how they compare in practice. This guide also gives advice on how to carry out the maintenance to achieve a high standard and minimise the risk of early failure. Since the condition of the coating or wood can vary considerably, guidance is given on the method and extent of surface preparation necessary.



Refixing ceramic wall tiles to internal walls

Good Repair Guide 29

The differential thermal and moisture movements associated with the background substrate and tiles can disrupt or break an inadequate bond within the tiling system. Effective adhesion of tiling requires:

good adhesion of tiles to the substrate, the use of a suitable adhesive for the substrate and conditions, dry, sound backing and substrate, and provision for movement joints in large areas of tiling.

This Good Repair Guide gives advice on how to prepare the background surface, apply the adhesive, build in movement joints and apply the grouting.

Almost every failure of tiling adhesion is the result of movement breaking the bond because:

- | the bond is unduly weak and so is broken by normal small thermal and other movements, and/or
- | excessive movement takes place, sufficient to disrupt what would otherwise have been a satisfactory bond.

The differential thermal and moisture movements associated with the background masonry, render and/or plaster substrate and tiles can disrupt or break an inadequate bond within the tiling system. Ceramic tiling expands rapidly immediately after manufacture but can continue to expand very slowly for many years. This long-term expansion may cause failure of the bond after many years of satisfactory service.

If the relative movements of the tiling and background are not taken into account, particularly in large tiled areas, or if the adhesive is not suitable for the background both as a material and in thickness, or the adhesion between each layer of construction is poor, the bond may fail and the tiles may bulge.



Figure 1 Problems continue to arise due to both short-term and long-term failure of the bond of tiling to its background or adhesive

Effective adhesion of tiling requires:

- | good adhesion of tiles to the substrate,
- | the use of a suitable adhesive for the substrate and conditions,
- | dry, sound backing and substrate, and
- | provision for movement joints in large areas of tiling.

Timber

Timber

Timber frame construction: an introduction	GG 60
Wood rot: assessing and treating decay	GR 12
Wood-boring insect attack part 1: Identifying and assessing damage	GR 13-1
Wood-boring insect attack part 1: Treating damage	GR 13-2

SAMPLE

Timber frame construction: an introduction

GBG 60

Charles Stirling

Over the past 75 years, timber framed housing has formed a substantial proportion of the Scottish construction market but a much smaller proportion in England and Wales. As building regulations require increased thermal standards, some forms of traditional masonry construction may not be able to accommodate the resulting thicker layer(s) of insulation. In addition, with increasing skills shortages and increasing demands for reduced construction times on site, there is a trend towards off-site fabricated building elements and components. This is likely to result in the increased specification and use of timber and steel frame construction techniques.

This Good Building Guide gives a brief introduction to the basics of timber frame construction.



Figure 1 Typical timber frame construction

Timber frame construction has been used extensively throughout the UK since the early 1920s. It may not be possible, from a cursory inspection of the building, to determine whether it is of timber frame construction or not (Figure 1).

There is a general perception that timber frame construction is at a higher risk from penetrating moisture and is therefore less durable. However,

when properly designed, specified and subsequently erected, a timber framed building will be at no greater risk than a traditionally constructed masonry building. There are many examples of timber framed buildings, albeit of a slightly different construction, which have lasted for a considerable period of time; the market hall at Thaxted, Essex, is just one example (Figure 2).



Figure 2 Medieval timber frame construction

Wood rot:

assessing and treating decay

Good Repair Guide 12

When it becomes damp, some timber is liable to deterioration and decay, with potentially serious implications for the structural integrity of the affected building. This is particularly true if the

timber becomes infected with dry rot, which can spread and can be difficult to eradicate. This guide contains advice on inspecting for wood rot, identifying and treating the different types, and the

repair or replacement of affected timbers. It should be read in conjunction with Good Repair Guide 13 on identifying and treating insect attack on timber.

Types of wood rot

Timber in buildings, when damp, is vulnerable to attack from two main types of fungal growth: wet rot and dry rot.

Wet rot includes two classes of rot, each of which produces characteristic signs of damage and decay. Brown rot leaves wood cross-cracked in cube-like shapes and brown in colour – white rot leaves the affected wood fibrous and pale in colour.

Serpula lacrymans, the true dry rot fungus, is a brown rot. Affected wood is brown and shows cuboidal cracking: the cubes tend to be larger than those of other brown rots. The dry rot fungus has some particular features that make it difficult to combat. For example:

- | It has a higher tolerance of alkaline conditions than wet rots, allowing it to spread through porous masonry materials in older properties
- | It does not damage masonry, but can rapidly spread *through* it to other timbers in contact with the infected wall, so speedy remedial action is essential
- | It can lie dormant in dry timbers for a year (or longer in cooler areas, such as cellars), and can be re-activated by the return of damp conditions

Soft rot is the superficial decay seen on external timbers (eg oak sills) in very damp conditions. It is not usually a source of serious damage in buildings. Blue-stain fungi give timber a blue-black colour, but do no structural damage. However, the presence of blue stain does indicate that the conditions are right for wet rot or dry rot to develop.

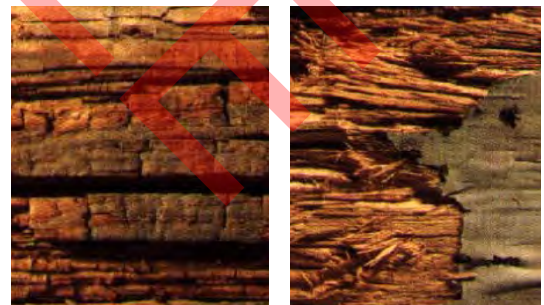

Typical brown rot (left) and white rot damage (right)



Dry rot damage, showing cube-like cracking

Wood-boring insect attack: identifying and assessing damage

Good Repair Guide 13

Part 1

good repair guide

Wood can be a food source for many insect species. Timber in buildings can be attacked by a range of wood-boring insects. Each insect has preferred timber species and some need the

wood to be decayed. Structural weakening can result from infestation by some beetles. This Guide contains advice on inspecting timber for wood-boring insects, and

identifying different types of attack. It should be read in conjunction with Good Repair Guide 12 on identifying and treating wood rot on timber.

Part 2 of this Guide

For dealing with wood-boring insect damage – see Part 2

Many insect species use wood as a food source, causing damage to timber by tunnelling into standing trees, freshly felled logs or wet decaying timber. A few beetles attack dry timber in buildings.

Eggs laid by adult beetles on timber surfaces, or in cracks in timber, hatch to release small grubs (larvae) which bore into the wood, feeding on it and creating a network of tunnels. The larvae of most wood-boring beetles fill the tunnels with excreted wood pellets known as *bore dust* or *frass*. The size, shape and cross-section of the tunnels, and the characteristics of the bore dust are useful in identifying the species of beetle (see photographs on page 2 and Table 1).

After feeding, usually for several years, the larvae undergo a transformation within the timber, through a pupal stage into the adult beetle. The beetles emerge, leaving the familiar 'woodworm' exit holes in the surfaces of the timber. The adults do not themselves cause further damage but, after mating, females often reinfest by laying their eggs in suitable timber. Damp conditions generally encourage infestation by most insects and, in particular, death watch beetle and common furniture beetle.

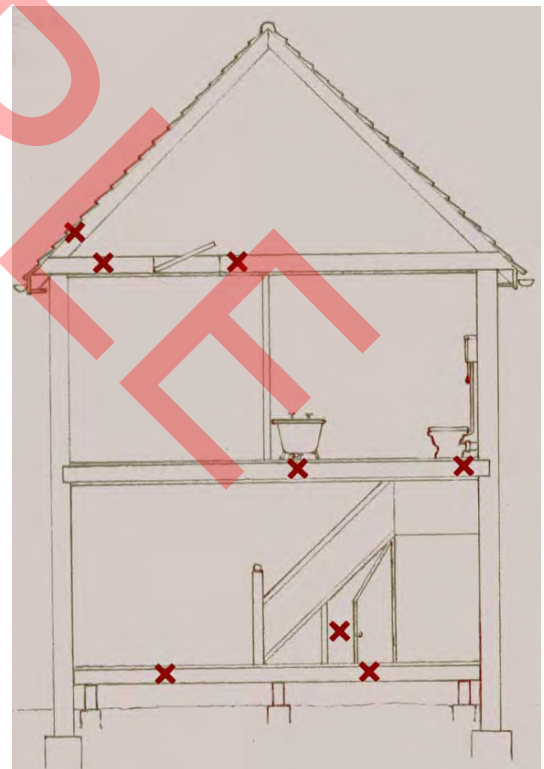

Areas at greatest risk from attack, particularly if they are damp

Wood-boring insect attack: treating damage

Good Repair Guide 13

Part 2

Wood can be a food source for many insect species. Timber in buildings can be attacked by a range of wood-boring insects. Each insect has preferred timber species and some need the

wood to be decayed. Structural weakening can result from infestation by some beetles. Part 2 of this Guide contains advice on treating different types of wood-

boring insect attack. It should be read in conjunction with Part 1 and Good Repair Guide 12 on assessing and treating wood rot decay.

Part 1 of this Guide

For identifying and assessing wood-boring insect damage – see Part 1

Remedial strategy for insect attack

- Step 1:** Locate timbers showing evidence of attack
- Step 2:** Identify the type of damage
- Step 3:** Assess activity and extent of damage
- Step 4:** Treat active infestations when necessary

Treating active infestations

Treatment of active infestations almost always consists of applying an insecticidal wood preservative to the surfaces of the timbers; this is usually done by spraying or, with deeper-seated infestations, by deep-penetrating paste or drilling and injection. Severely weakened timbers should be repaired with preservative-treated timber or reinforced resin, or replaced with preservative-treated timbers, or steel or concrete substitute units.

See Flow chart on page 3 for guidance on deciding if remedial treatment is needed and Flow chart on page 4 for advice on selecting the remedial product and application method. Products must be applied in accordance with manufacturers' instructions.

Precautionary preventive treatment

If you are in doubt about whether an insect infestation is extinct, you may think there is justification for specifying remedial treatment to provide a guarantee of freedom from infestation. However, in these circumstances, the decision to treat should only be taken after a COSHH (Control of Substances Hazardous to Health Regulations 1988; revised 1994) assessment has been made in which other factors, such as ease of access for future treatment, are considered. The purpose of the assessment is to decide if hazardous substances (such as wood preservatives) need to be used, to determine the level of risk associated with the particular use, and to identify appropriate measures to protect operatives and others.

Types of preservative treatment

The most commonly used remedial wood preservatives for control of wood-boring insects are organic solvent-based and microemulsion (water-based) liquid products. They both contain similar types and levels of active insecticide. Paste products penetrate deeply but are not suitable for widespread application. They are more costly than the liquid products. See page 5 for a detailed discussion of types of preservative treatment.

If infestation is localised, you don't need to